



PRODUCT LINE / 2017

PROTECH
MADE IN USA

AS RUGGED AS THE JOB



BEHIND THE NAME

ProTech Industries began in a garage. Seriously. In 1980 ProTech started making cab racks and toolboxes, primarily for Class 8 trucks. By 1982 it was necessary to incorporate the company and, seven years later, add a manufacturing plant in Tennessee.

Currently ProTech Industries has two manufacturing facilities and a growing number of regional distribution locations. The Vancouver, WA operation houses the manufacturing, sales, customer service and distribution center for the western U.S. and Canada. La Vergne, TN is the center for manufacturing, sales, customer service and distribution for the eastern U.S. and Canada.

FROM STANDARD TO FAR-FROM-STANDARD SOLUTIONS

Certainly ProTech Industries produces standard catalog products. But when standard products won't do the job for our customers, ProTech also lets customers configure catalog products or create their own design in the ProTech Build To Spec™ program.

Build To Spec helps our customers create purpose-built solutions for hard-working trucks, from small pickups to class-8 vocational trucks, tractor/trailers — even for UTVs. Typical products include flatbeds, storage boxes, toolboxes, drawer modules, decks, racks, bulkheads and baskets. BTS let's you optimize — and standardize — components for your required use.

It's our approach to making our products that defines our product quality and our ability to meet customer expectations. The ProTech Production System — aka PPS — is a uniform process that combines the efficiencies of product platform modularity, lean manufacturing and company-wide quality processes. The approach allows small-scale manufacturing as well as high-volume orders.

Whether it's a single standard product or an extremely complicated special design, each product is made to last a long, long time on hard working trucks. That's what's behind the name we put on our products.



PROTECH PRODUCT LINEUP



MEDIUM-DUTY TO CLASS-8

Cab Racks, Enclosures & Droms p 4-14

- Cab Racks
- Cab Rack Enclosures
- Cab Rack Mounting Kits
- Drom Cab Rack Assemblies
- Drom Mounting Kits
- Cab Rack Options
 - Window Assemblies
 - Enclosure Shelves
 - Chain Hangers
 - Chain Trays
 - Cab Rack Tool Box
 - Light Bars, Brackets And Lights
 - Load Lock Carriers

Frame Mount Products p 14-16

- Chain Hangers
- Chain Trays
- Deck Covers
- Deck Plate Mounting Kits
- Frame Steps

Aluminum Storage Boxes p 17-25

- Drop-Down Doors Toolboxes
- Side swing Door Toolboxes
- Step Boxes
- Top-Step Boxes
- Cab-Entry Step Boxes
- Battery Boxes
- In-Frame Toolboxes

Steel Storage Boxes p 26-31

- Steel Toolboxes
- Steel Toolbox Shelves
- Steel Toolbox Mounting Brackets

Drawer Modules p 31

Fenders & Mounting Brackets p 32-35

- Full Tandem, Single Radius
- Full Tandem, Double Radius
- Half Tandem Single Radius Fender
- Full Radius, Single Tire Fenders
- Half Circle, Single Axle Fenders
- Mounting Bracket Kits
- Fender Bracket Guide

Fenders Brackets p 36-37

PICKUP TRUCK PRODUCTS

Pickup Truck Toolboxes p 38-48

- Cross-Body Boxes
- In-Bed Chest-Style Boxes
- Wheel Well Box
- Drop-Door Side Rail Boxes
- Top-Open, Drop-Door Contractor Boxes
- Cross-Body Toolbox Fitment Guide
- Trailer Tongue Boxes

Pickup Truck Cab Racks p 49-56

- Cab Racks — Amplimesh
- Powder Coat Options
- Cab Racks — Louver
- Rear Cargo Rack Hoop
- Pickup Truck Cab Rack Options
 - Lights
 - Antenna
 - Sign Assemblies
 - Light Brackets
 - Cab Rack — Round Tube
- Pickup Cab Rack Fit Chart

Standard Flatbeds p 57

- Rancher Body

Build To Spec™ Program p 58-59

MEDIUM-DUTY TO CLASS-8

PROTECH CLASS-8 CAB RACKS AND ENCLOSURES

ProTech sets a higher industry standard for cab racks, with continual-seam weldments that virtually eliminate moisture trapping, cracking and fatigue.

FEATURES



Tubes are mitered and joined with TIG welds that are hand-cleaned and buffed



KEY POINTS

- 6061 window tubes
- Weld residue is removed and welds buffed
- Two 14-position locking chain hangers
- Structural panels are 5052 marine grade aluminum and are resistant to corrosion especially salt-water atmosphere
- Locking center-mount toolbox
- Two chain trays
- Robust, durable continuous welds join the structural rib aluminum panel to ProTech® hept-tubes

STANDARD RACK AND INSTALLED OPTIONS

The standard unit is 65" H x 70"W and includes a window (10-5000), two locking chain hangers (10-5903), two chain trays (10-3800), and a locking center mount toolbox (20-2401). The units can be customized to fit any need.

← SHOWN PN10-1003-592

Extruded I-beam uprights and legs form the support structure

Rack legs are 0.25" walls of 6061 aluminum alloy

HEPT-TUBE CONSTRUCTION

Aluminum hept-tube construction, with no bends, delivers the equivalent deflection strength of steel with significant weight savings and durability. The tube panel structure is welded to cab rack legs.



PROTECH CAB RACK

With chain hangers, chain trays and center-mount toolbox

CAB RACKS / CAB RACK ENCLOSURES / DROMS

RACKS

STANDARD RACKS

Available height: 65" H or 68" H. Available widths: 70" W; 80" W; 86" W and 90" W

STANDARD CAB RACK WITH WINDOW

Window can be ordered in any cab rack. Specific heights require measuring from top of truck frame to window centerline.

DELUXE CAB RACK

Comes standard with two chain hangers and a full chain tray (Model DX-3) or two chain trays (Model DX-4). These units can also be equipped with optional stop/turn/tail lights.

COMBINATIONS ABOUND

Cab racks can be configured with window assemblies in two positions, various styles and two widths. Chain hangers and trays can be ordered installed or loose, as well as lights, light brackets, load bars and other accessories.

Check the ProTech product price book for the complete list of standard items offered. When placing your order, simply take the base cab rack and then add the option part number and indicate "installed."

MOUNTING KITS

Designed specifically for mounting ProTech cab racks and enclosures, the mounting kit (10-9401) includes 19" bolts and other hardware; use the J-hook mounting kit (10-9407) for limited space installations.

NOTE: The correct ProTech mounting kit must be used and the mounting instructions must be followed to meet the cab rack load rating.

MOUNTING KIT REFERENCE



Position mounting bracket over gusset cap flange



Up-right mounting bracket

Mounting bolts

J-hook forward I-beam position only



10-1083 and 10-5030

SHOWN: 10-1083 and 10-5030
Standard, ribbed diamond plate panel cab rack with the high-mount, 86" full-width bar-style window



10-1003-5000

SHOWN: 10-1003-5000 Ribbed diamond plate cab rack, 70"W x 65"H with high-mount 27"W x 18"H bar-style window (10-5000)



10-1074

SHOWN: 10-1074 Class-8 space saver, 70"W x 64"H standard diamond plate cab rack for 34.5" frame width; angle mounting, with isolation spacers included. Shown with two locking chain hangers (10-5903) and cab rack chain tray with center recessed panel (10-3315) options installed.



10-4210 on 10-1003

SHOWN: 10-4210 on 10-1003
Overload wood sign on air-actuated sign bracket; installed on the 10-1003 standard cab rack

MEDIUM-DUTY TO CLASS-8



MODULAR ENCLOSURES

SHOWN: 10-1167 Modular enclosure cab rack with internal uprights and three 14" deep compartments in a mill-finish body with stainless steel locking T-latches on diamond plate doors; a chain hanger (5903NL) is in each outside compartment.



ENCLOSURES WITH WINDOWS

SHOWN: 10-1153 Three-door, 14" deep compartment enclosure cab rack with a 27"W x 18"H bar-style window (5000) and polished body with stainless steel locking T-latches on diamond plate doors; chain hangers are in each outside compartment.



CENTER CABINET CAB RACK

SHOWN: 10-1110 Center cabinet in a diamond plate ribbed panel welded on the hept-tube cab rack frame; the diamond plate doors have stainless steel locking T-latches; the enclosure has a top shelf (2515) and a chain hanger (5903NL) installed.



THREE-DOOR ENCLOSURES

SHOWN: 10-1150 Three 14" deep compartment enclosure cab rack 86"W x 68"H, with a polished body and stainless steel locking T-latches on diamond plate doors — chain hangers are in each outside compartment.

CAB RACK ENCLOSURES

STANDARD ENCLOSURE

Three-door 14-inch deep compartments provide 37 cubic feet of storage within the 68-inch high enclosure. Widths are 80-inches or 86-inches. Chain hangers are included in each outside compartment.

ENCLOSURE WITH WINDOW

Three-door 14-inch deep compartments provide 30 cubic feet of storage within the 68" H enclosure. Widths are 80-inches or 86-inches. Chain hangers are included in each outside compartment; shelves are an option.

3-DOOR MODULAR ENCLOSURE

Three individual compartment sections, with chain hangers included in each outside compartment. Shelves are an option for each compartment. Enclosure depth available in 8" D (10-1160) or 14" D (10-1167) and mill finish body is standard.

CENTER CABINET CAB RACK

Center cabinet depth of 8.5". Available in three sizes: 68" H x 86" W, 68" H x 70" W, and 65" H x 70" W. Includes top shelf as well as a chain hanger inside of cabinet. Available with angled feet for additional clearance. 10-74CE and 10-1094CE

MOUNTING KITS

Designed specifically for mounting ProTech cab racks and enclosures, the mounting kit (10-9401) includes 19" bolts and other hardware; use the J-hook mounting kit (10-9407) for limited space installations.



10-9401



10-9407

NOTE: The correct ProTech mounting kit must be used and the mounting instructions must be followed to meet the cab rack load rating.

ENCLOSURES ARE AVAILABLE WITH ALUMINUM DIAMOND PLATE, POLISHED ALUMINUM, OR STAINLESS STEEL DOORS.



WESTERN STAR TRUCK

ProTech three-compartment enclosure

CAB RACKS / CAB RACK ENCLOSURES / DROMS

DROMS

DROM CONFIGURATIONS

Drom decks are diamond plate and range from 30 inches to 8 feet; all decks have side gussets. Measurements are from the forward part of uprights to the rear of the deck. Special sizes, as well as options, are available.

The standard drom cab rack configuration is a ribbed diamond plate panel welded into a tri-tube frame 68"H in widths of 86" and 96". For conventional-model power units, without a sleeper, it is 68"H x 96"W.

DROM ENCLOSURE

Three-door compartment configuration, provides 50 cubic feet of storage within the 68" H x 14" D x 96" W enclosure (10-2000) and 37 cubic feet within the 68" H x 14" D x 86" W enclosure (10-2010). Chain hangers are included in each outside compartment. Available on any drom assembly.

OPTIONS

- Window assemblies in louvered, Amplimesh and bar-style configurations — as well as placement — are available as a special order.
- Drom enclosure options include installed shelves (in left, right or center positions), chain hangers and frame mount aluminum steps.

MOUNTING KITS

Designed specifically for mounting ProTech Drom assemblies, mounting kits are available as flat bar and J-hook styles. For Droms up to 4-feet long use 10-9501 (flat bar) or 10-9507 (J-hook); for Droms 4.5-feet or longer use mounting kit 10-9601 (flat-bar) or 10-9601 (J-hook).

NOTE: The correct ProTech mounting kit must be used and the mounting instructions must be followed to meet the cab rack load rating.



DROM ENCLOSURE

SHOWN: 10-2000 Three compartment, 14" deep, drom enclosure with 50 cubic feet of storage, neoprene bulb-type seals and stainless steel T-latches on diamond doors with chain hangers in each side compartment



DROM CAB RACK

SHOWN: 10-1255 Drom standard cab rack with ribbed diamond plate panel welded into a tri-tube frame, 26"H gussets and a diamond plate cargo deck rated at 1,000 lb/LFT The side rail inside flange takes flat-hook straps.

KEY POINTS CAB RACK ENCLOSURES AND DROMS

- Panels are 5052 marine grade aluminum and resistant to corrosion, especially salt-water atmosphere
- Enclosure mounted with continuous welds to 6061 aluminum alloy triangular-tube frame
- Welds are hand-cleaned and buffed; structure is welded to deck
- Drom enclosure legs are I-beam extrusions of 6061 aluminum
- Stainless steel T-locks with keyed latches
- Neoprene, automotive bulb seals on compartment openings keep weather out

MEDIUM-DUTY TO CLASS-8



↑ MOUNTED CHAIN HANGERS

SHOWN: 11-5903



↑ INSTALLED CHAIN TRAYS

SHOWN: 10-3800



↑ CENTER-MOUNT TOOLBOXES

SHOWN: 20-2401



↑ LOAD LOCK CARRIERS

SHOWN: 35-5509 Two-bar load lock carrier; Vertical mount, single clamp with boot.



↑ LIGHT BARS

SHOWN: 35-4480 Frame-mount light bar; four holes; 42.25"W x 5.75"H



↑ LIGHT BRACKETS

SHOWN: 10-4460 Adjustable light bracket and 10-4450 beacon light bracket



↑ LIGHT ASSEMBLIES

SHOWN: 10-4425 Round light assembly (Stop/Tail/Turn)



↑ ADDITIONAL ACCESSORIES

SHOWN: 10-5200 Welded-on grab handle

CAB RACK, ENCLOSURE AND DROM OPTIONS

MOUNTED CHAIN HANGERS

Options for chain hangers mounted on the cab rack order include three lockable top-open cover finishes: diamond plate, buffed and mill finish. A coverless option is available for mounting in enclosures. All are available loose.

INSTALLED CHAIN TRAYS

Standard installed chain tray is 18"W x 12" deep x 10"H. Chain trays are available in standard 8", 9" and 12" depths installed with order or loose and varying widths, including full cab rack width. Available loose.

CENTER-MOUNT CAB RACK TOOLBOX

Center-mount aluminum toolbox with sloping diamond plate lid, neoprene, water-resistant, automotive-style bulb seals and stainless steel locking T-handle; available installed with order or separately.

LOAD LOCK CARRIERS

Available as two-bar and four-bar load locker and boot for universal mounting in vertical or horizontal installations. Offered installed and loose.

ALUMINUM LIGHT BARS

Three frame-mounted light bars (2, 4 and 6 hole) in 12.5", 42.25" and 46.5" lengths for easy frame access. Universal mounting.

BRACKETS AND LIGHTS

A variety of lights and brackets are available for install on cab racks, enclosures and droms.

ADDITIONAL ACCESSORIES

The welded-on grab handle is one of many accessories you can add to make your life easier. ProTech offers hose racks, axe and shovel holders, winch tie-downs as well as strap and rope hooks. Just ask our customer service representative about various configurations.

DESIGN YOUR OWN

Some truck owners need a cab rack or enclosure that's really different. If that sounds like you, let's talk. We can make it happen. Dream big.

CAB RACKS / CAB RACK ENCLOSURES / DROMS

STANDARD CAB RACKS		W"	D"	H"
10-1003	STANDARD C-8 CAB RACK; HEPT-TUBE FRAME; RIBBED DIAMOND PLATE PANEL	70	29.5	65
10-1003S	STANDARD C-8 CAB RACK; HEPT-TUBE FRAME; SMOOTH ALUMINUM PANEL	70	29.5	65
10-1003-5000	STANDARD C-8 CAB RACK; HEPT-TUBE FRAME; RIBBED DIAMOND PLATE PANEL WITH HIGH-MOUNT 27"W x18"H BAR-STYLE WINDOW 5000	70	29.5	65
10-1003-592	STANDARD C-8 CAB RACK; HEPT-TUBE FRAME; RIBBED DIAMOND PLATE PANEL WITH HIGH-MOUNT 27"W x18"H BAR-STYLE WINDOW 5000; SLOPE-TOP TOOLBOX 2401; 2 CHAIN HANGERS 5903; 2 CHAIN TRAYS 3800	70	29.5	65
10-1003-DX3	STANDARD C-8 CAB RACK; HEPT-TUBE FRAME; RIBBED DIAMOND PLATE PANEL WITH 2 CHAIN HANGERS 5903; FULL WIDTH TRAY 3601	70	29.5	65
10-1003-DX3W	STANDARD C-8 CAB RACK; HEPT-TUBE FRAME; RIBBED DIAMOND PLATE PANEL WITH HIGH-MOUNT 27"W x18"H BAR-STYLE WINDOW; 2 CHAIN HANGERS 5903; FULL WIDTH TRAY 3601	70	29.5	65
10-1003-DX4	STANDARD C-8 CAB RACK; HEPT-TUBE FRAME; RIBBED DIAMOND PLATE PANEL WITH 2 CHAIN HANGERS 5903; 2 CHAIN TRAYS 3800	70	29.5	65
10-1003-DX4W	STANDARD C-8 CAB RACK; HEPT-TUBE FRAME; RIBBED DIAMOND PLATE WITH HIGH-MOUNT 27"Wx18"H BAR-STYLE WINDOW 5000; 2 CHAIN HANGERS 5903; 2 CHAIN TRAYS 3800	70	29.5	65
10-1033	STANDARD C-8 CAB RACK; HEPT-TUBE FRAME; RIBBED DIAMOND PLATE PANEL	70	29.5	68
10-1033S	STANDARD C-8 CAB RACK; HEPT-TUBE FRAME; SMOOTH PANEL	70	29.5	68
10-1033-5000	STANDARD C-8 CAB RACK; HEPT-TUBE FRAME; RIBBED DIAMOND PLATE PANEL WITH HIGH-MOUNT 27"Wx-18"H BAR-STYLE WINDOW 5000	70	29.5	68
10-1033-5005	STANDARD C-8 CAB RACK; HEPT-TUBE FRAME; RIBBED DIAMOND PLATE PANEL WITH 27"Wx18"H BAR-STYLE WINDOW 5005 CENTER LINE 51" ABOVE FRAME-TOP	70	29.5	68
10-1033-592	STANDARD C-8 CAB RACK; HEPT-TUBE FRAME; RIBBED DIAMOND PLATE PANEL WITH HIGH-MOUNT 27"Wx-18"H BAR-STYLE WINDOW; SLOPE TOP TOOLBOX 2401 BETWEEN FEET; 2 CHAIN HANGERS 5903; 2 CHAIN TRAYS 3800	70	29.5	68

STANDARD CAB RACKS (Continued)		W"	D"	H"
10-1033-DX3	STANDARD C-8 CAB RACK; HEPT-TUBE FRAME; RIBBED DIAMOND PLATE PANEL; 2 CHAIN HANGERS 5903; FULL WIDTH TRAY 3601	70	29.5	68
10-1033-DX3W	STANDARD C-8 CAB RACK; HEPT-TUBE FRAME; RIBBED DIAMOND PLATE PANEL WITH HIGH-MOUNT 27"Wx-18"H BAR-STYLE WINDOW 5000; 2 CHAIN HANGERS 5903; 2 CHAIN TRAYS 3800	70	29.5	68
10-1033-DX4	STANDARD C-8 CAB RACK; HEPT-TUBE FRAME; RIBBED DIAMOND PLATE PANEL; 2 CHAIN HANGERS 5903; 2 CHAIN TRAYS 3800	70	29.5	68
10-1033-DX4W	STANDARD C-8 CAB RACK; HEPT-TUBE FRAME; RIBBED DIAMOND PLATE PANEL WITH HIGH-MOUNT 27"Wx-18"H BAR-STYLE WINDOW 5000; 2 CHAIN HANGERS 5903; 2 CHAIN TRAYS 3800	70	29.5	68
10-1083	STANDARD C-8 CAB RACK; HEPT-TUBE FRAME; RIBBED DIAMOND PLATE PANEL	80	29.5	68
10-1083-DX3	STANDARD C-8 CAB RACK; HEPT-TUBE FRAME; RIBBED DIAMOND PLATE PANEL WITH 2 CHAIN HANGERS 5903; FULL WIDTH TRAY 3541	80	29.5	68
10-1083-DX3W	STANDARD C-8 CAB RACK; HEPT-TUBE FRAME; RIBBED DIAMOND PLATE PANEL WITH HIGH-MOUNT 27"Wx-18"H BAR-STYLE WINDOW 5000; 2 CHAIN HANGERS 5903; FULL WIDTH TRAY 3541	80	29.5	68
10-1083-DX4	STANDARD C-8 CAB RACK; HEPT-TUBE FRAME; RIBBED DIAMOND PLATE PANEL WITH 2 CHAIN HANGERS 5903; 2 CHAIN TRAYS 3700	80	29.5	68
10-1083-DX4W	STANDARD C-8 CAB RACK; HEPT-TUBE FRAME; RIBBED DIAMOND PLATE PANEL WITH HIGH-MOUNT 27"Wx-18"H BAR-STYLE WINDOW 5000; 2 CHAIN HANGERS 5903; 2 CHAIN TRAYS 3700	80	29.5	68
10-1093	STANDARD C-8 CAB RACK; HEPT-TUBE FRAME; RIBBED DIAMOND PLATE PANEL	86	29.5	68
10-1093S	STANDARD C-8 CAB RACK; HEPT-TUBE FRAME; SMOOTH PANEL, HEPT-TUBE	86	29.5	68
10-1093-DX3	STANDARD C-8 CAB RACK; HEPT-TUBE FRAME; RIBBED DIAMOND PLATE PANEL WITH 2 CHAIN HANGERS 5903; FULL WIDTH TRAY 3508	86	29.5	68
10-1093-DX3W	STANDARD C-8 CAB RACK; HEPT-TUBE FRAME; RIBBED DIAMOND PLATE PANEL WITH HIGH-MOUNT 27"Wx-18"H BAR-STYLE WINDOW 5000; 2 CHAIN HANGERS 5903; FULL WIDTH TRAY 3508	86	29.5	68

MEDIUM-DUTY TO CLASS-8

STANDARD CAB RACKS (Continued)		W"	D"	H"
10-1093-DX4	STANDARD C-8 CAB RACK; HEPT-TUBE FRAME; RIBBED DIAMOND PLATE PANEL WITH 2 CHAIN HANGERS 5903; 2 CHAIN TRAYS 3700	86	29.5	68
10-1093-DX4W	STANDARD C-8 CAB RACK; HEPT-TUBE FRAME; RIBBED DIAMOND PLATE PANEL WITH HIGH-MOUNT 27"W x18"H BAR-STYLE WINDOW; 2 CHAIN HANGERS 5903; 2 CHAIN TRAYS 3700	86	29.5	68
10-1103	STANDARD C-8 CAB RACK; HEPT-TUBE FRAME; RIBBED DIAMOND PLATE PANEL	90	29.5	68
10-1203	STANDARD C-8 CAB RACK; HEPT-TUBE FRAME; RIBBED DIAMOND PLATE PANEL	86	29.5	80
CAB RACK — SPACE SAVER		W"	D"	H"
10-1072	SPACE SAVER STANDARD C-8 CAB RACK; HEPT-TUBE FRAME; RIBBED DIAMOND PLATE PANEL; FOR 34.5" FRAME WIDTH; ANGLE MOUNTING; ISOLATION SPACERS INCLUDED	70	18	68
10-1074	SPACE SAVER STANDARD C-8 CAB RACK; HEPT-TUBE FRAME; RIBBED DIAMOND PLATE PANEL; FOR 34.5" FRAME WIDTH; ANGLE MOUNTING; ISOLATION SPACERS INCLUDED	70	18	65
10-1084	SPACE SAVER STANDARD C-8 CAB RACK; HEPT-TUBE FRAME; RIBBED DIAMOND PLATE PANEL; FOR 34.5" FRAME WIDTH; ANGLE MOUNTING; ISOLATION SPACERS INCLUDED	80	18	68
10-1094	SPACE SAVER STANDARD C-8 CAB RACK; HEPT-TUBE FRAME; RIBBED DIAMOND PLATE PANEL FOR 34.5" FRAME WIDTH; ANGLE MOUNTING; ISOLATION SPACERS INCLUDED	86	18	68
CAB RACK — CENTER CABINET		W"	D"	H"
10-1110	CAB RACK CENTER CABINET; 8.5"D WITH DIAMOND PLATE DOORS AND STAINLESS STEEL LOCKING T-LATCHES; TOP SHELF (2515) AND CHAIN HANGER (5903NL) INSTALLED; HEPT-TUBE FRAME; RIBBED DIAMOND PLATE PANEL	86	29.5	68
10-1013	CAB RACK CENTER CABINET; 8.5"D WITH DIAMOND PLATE DOORS AND STAINLESS STEEL LOCKING T-LATCHES; TOP SHELF (2515) AND CHAIN HANGER (5903NL) INSTALLED; HEPT-TUBE FRAME; RIBBED DIAMOND PLATE PANEL	70	29.5	68

CAB RACK — CENTER CABINET (Continued)		W"	D"	H"
10-1074-CE	SPACE SAVER CAB RACK CENTER CABINET; 8.5"D WITH DIAMOND PLATE DOORS AND STAINLESS STEEL LOCKING T-LATCHES; TOP SHELF (2515) AND CHAIN HANGER (5903NL) INSTALLED; HEPT-TUBE FRAME; RIBBED DIAMOND PLATE PANEL; ANGLE MOUNTING; ISOLATION SPACERS INCLUDED	70	18	65
10-1094-CE	SPACE SAVER CAB RACK CENTER CABINET; 8.5"D WITH DIAMOND PLATE DOORS AND STAINLESS STEEL LOCKING T-LATCHES; TOP SHELF (2515) AND CHAIN HANGER (5903NL) INSTALLED; HEPT-TUBE FRAME; RIBBED DIAMOND PLATE PANEL; ANGLE MOUNTING; ISOLATION SPACERS INCLUDED	86	18	68
CAB RACK ENCLOSURES		W"	D"	H"
10-1155	2-COMPARTMENT ENCLOSURE, 14"D WITH DIAMOND PLATE DOORS AND STAINLESS STEEL LOCKING T-LATCHES; TOP SHELF (2515) AND CHAIN HANGER (5903NL) INSTALLED IN EACH COMPARTMENT; POLISHED BODY	70	29.5	68
10-1143	3-COMPARTMENT ENCLOSURE, 14"D WITH DIAMOND PLATE DOORS AND STAINLESS STEEL LOCKING T-LATCHES; CHAIN HANGER (5903NL) IN EACH OUTSIDE COMPARTMENT; 27"Wx18"H BAR-STYLE WINDOW 5000; POLISHED BODY	86	29.5	68
10-1143S	3-COMPARTMENT ENCLOSURE, 14"D WITH POLISHED ALUMINUM DOORS AND STAINLESS STEEL LOCKING T-LATCHES; CHAIN HANGER (5903NL) IN EACH OUTSIDE COMPARTMENT; 27"Wx18"H BAR-STYLE WINDOW 5000; POLISHED BODY	86	29.5	68
10-1150	3-COMPARTMENT ENCLOSURE, 14"D WITH DIAMOND PLATE DOORS AND STAINLESS STEEL LOCKING T-LATCHES; CHAIN HANGER (5903NL) IN EACH OUTSIDE COMPARTMENT; POLISHED BODY	86	29.5	68
10-1150S	3-COMPARTMENT ENCLOSURE, 14"D WITH POLISHED ALUMINUM DOORS AND STAINLESS STEEL LOCKING T-LATCHES; CHAIN HANGER (5903NL) IN EACH OUTSIDE COMPARTMENT; POLISHED BODY	86	29.5	68
10-1151	3-COMPARTMENT ENCLOSURE, 14"D WITH DIAMOND PLATE DOORS AND STAINLESS STEEL LOCKING T-LATCHES; CHAIN HANGER (5903NL) IN EACH OUTSIDE COMPARTMENT; POLISHED BODY	80	29.5	68

CAB RACKS / CAB RACK ENCLOSURES / DROMS

CAB RACK ENCLOSURES (Continued)		W"	D"	H"	DROM CAB RACK ASSEMBLIES (Continued)		W"	D"	H"
10-1151S	3-COMPARTMENT ENCLOSURE, 14"D WITH POLISHED ALUMINUM DOORS AND STAINLESS STEEL LOCKING T-LATCHES; CHAIN HANGER (5903NL) IN EACH OUTSIDE COMPARTMENT; POLISHED BODY	80	29.5	68	10-1255	DROM, FOR CONVENTIONAL-MODEL POWER UNITS; RIBBED DIAMOND PLATE PANEL; TRI-TUBE; DIAMOND PLATE CARGO DECK CARRIES 1000 Lb/LFT; GUSSET 26" HIGH; SIDE RAIL INSIDE FLANGE TAKES FLAT-HOOK STRAPS	70	30	68
10-1153	3-COMPARTMENT ENCLOSURE, 14"D WITH DIAMOND PLATE DOORS AND STAINLESS STEEL LOCKING T-LATCHES; CHAIN HANGER (5903NL) IN EACH OUTSIDE COMPARTMENT; 27"WX18"H BAR-STYLE WINDOW 5000; POLISHED BODY	80	29.5	68	10-1400	DROM, FOR CONVENTIONAL-MODEL POWER UNITS; RIBBED DIAMOND PLATE PANEL; TRI-TUBE; DIAMOND PLATE CARGO DECK CARRIES 1000 Lb/LFT; GUSSET 26" HIGH; SIDE RAIL INSIDE FLANGE TAKES FLAT-HOOK STRAPS	96	48	68
CAB RACK MODULAR ENCLOSURES		W"	D"	H"	10-1403	DROM, FOR CONVENTIONAL-MODEL POWER UNITS; RIBBED DIAMOND PLATE PANEL; TRI-TUBE; DIAMOND PLATE CARGO DECK CARRIES 1000 Lb/LFT; GUSSET 26" HIGH; SIDE RAIL INSIDE FLANGE TAKES FLAT-HOOK STRAPS	86	48	68
10-1160	3-COMPARTMENT MODULAR ENCLOSURE, 8"D WITH DIAMOND PLATE DOORS AND STAINLESS STEEL LOCKING T-LATCHES; CHAIN HANGER (5903NL) IN EACH OUTSIDE COMPARTMENT; INTERNAL UPRIGHTS; MILL FINISH BODY	86	29.5	68	10-1500	DROM, FOR CONVENTIONAL-MODEL POWER UNITS; RIBBED DIAMOND PLATE PANEL; TRI-TUBE; DIAMOND PLATE CARGO DECK CARRIES 1000 Lb/LFT; GUSSET 26" HIGH; SIDE RAIL INSIDE FLANGE TAKES FLAT-HOOK STRAPS	96	60	68
10-1167	3-COMPARTMENT MODULAR ENCLOSURE, 14"D WITH DIAMOND PLATE DOORS AND STAINLESS STEEL LOCKING T-LATCHES; CHAIN HANGER (5903NL) IN EACH OUTSIDE COMPARTMENT; INTERNAL UPRIGHTS; MILL FINISH BODY	86	35.5	68	10-1600	DROM, FOR CONVENTIONAL-MODEL POWER UNITS; RIBBED DIAMOND PLATE PANEL; TRI-TUBE; DIAMOND PLATE CARGO DECK CARRIES 1000 Lb/LFT; GUSSET 26" HIGH; SIDE RAIL INSIDE FLANGE TAKES FLAT-HOOK STRAPS	96	72	68
MOUNTING KITS — CAB RACK and CAB RACK ENCLOSURES MOUNTING KITS		W"	D"	H"	10-1603	DROM, FOR CONVENTIONAL-MODEL POWER UNITS; RIBBED DIAMOND PLATE PANEL; TRI-TUBE; DIAMOND PLATE CARGO DECK CARRIES 1000 Lb/LFT; GUSSET 26" HIGH; SIDE RAIL INSIDE FLANGE TAKES FLAT-HOOK STRAPS	86	72	68
10-9401	CAB RACK MOUNTING KIT; PLATES AND 19" BOLTS				10-1800	DROM, FOR CONVENTIONAL-MODEL POWER UNITS; RIBBED DIAMOND PLATE PANEL; TRI-TUBE; DIAMOND PLATE CARGO DECK CARRIES 1000 Lb/LFT; GUSSET 26" HIGH; SIDE RAIL INSIDE FLANGE TAKES FLAT-HOOK STRAPS	96	96	68
10-9407	LIMITED SPACE CAB RACK MOUNTING KIT; TWO J-HOOKS AND FOUR 19" BOLTS				10-1803	DROM, FOR CONVENTIONAL-MODEL POWER UNITS; RIBBED DIAMOND PLATE PANEL; TRI-TUBE; DIAMOND PLATE CARGO DECK CARRIES 1000 Lb/LFT; GUSSET 26" HIGH; SIDE RAIL INSIDE FLANGE TAKES FLAT-HOOK STRAPS	86	96	68
10-9407J	SPACE SAVER MOUNTING KIT; GALVANIZED BRACKETS FOR ANGLE MOUNT WITH TWO J-HOOKS AND FOUR 19" BOLTS								
10-9469	OFFSET FOOT MOUNTING KIT BRACKET								
DROM CAB RACK ASSEMBLIES		W"	D"	H"					
10-1250	DROM, FOR CONVENTIONAL-MODEL POWER UNITS; RIBBED DIAMOND PLATE PANEL; TRI-TUBE; DIAMOND PLATE CARGO DECK CARRIES 1000 Lb/LFT; GUSSET 26" HIGH; SIDE RAIL INSIDE FLANGE TAKES FLAT-HOOK STRAPS	96	30	68					
10-1253	DROM, FOR CONVENTIONAL-MODEL POWER UNITS; RIBBED DIAMOND PLATE PANEL; TRI-TUBE; DIAMOND PLATE CARGO DECK CARRIES 1000 Lb/LFT; GUSSET 26" HIGH; SIDE RAIL INSIDE FLANGE TAKES FLAT-HOOK STRAPS	86	30	68					

MEDIUM-DUTY TO CLASS-8

DROM CAB RACK WITH ENCLOSURES, CONFIGURED OPTIONS AND ACCESSORIES		W"	D"	H"
10-2000	3-DOOR ENCLOSURE ADDED TO DROM CAB RACK; 14"D COMPARTMENTS; DIAMOND PLATE DOORS; STAINLESS STEEL KEYED LATCHES; CHAIN HANGERS IN EACH SIDE COMPARTMENT; 50 CF STORAGE; NEOPRENE BULB-TYPE SEALS.	96	14	86
10-2010	3-DOOR ENCLOSURE ADDED TO DROM CAB RACK; 14" DEEP COMPARTMENTS; DIAMOND PLATE DOORS; STAINLESS STEEL KEYED LATCHES; CHAIN HANGERS IN EACH SIDE COMPARTMENT 50 CF STORAGE; NEOPRENE BULB-TYPE SEALS	86	14	68
10-2515	SHELF INSTALLED; SPECIFY LEFT, RIGHT OR CENTER POSITION	28	14	1.125
10-5903NL	CHAIN HANGER INSTALLED IN ENCLOSURE; NO-LID	23.25	2.5	3
35-5225	FRAME MOUNT ALUMINUM STEP FOR DROMS; SHIPS LOOSE	12	5	26
DROM MOUNTING KITS — MANDATORY		W"	D"	H"
10-9501	MOUNTING KIT FOR DROMS UP TO 48" DEEP			
10-9601	MOUNTING KIT FOR DROM ASSEMBLY 54" TO 96" DEEP			
10-9507	MOUNTING KIT WITH TWO J-HOOKS FOR DROMS TO 48" DEEP			
10-9607	MOUNTING KIT WITH TWO J-HOOKS FOR DROM ASSEMBLY 54" TO 96" DEEP			
TRAILER BULKHEADS		W"	D"	H"
15-1210	TRAILER BULKHEAD 10" RETURN FOR 96" WIDE TRAILER	96	10	48
15-1215	TRAILER BULKHEAD 24" RETURN FOR 96" WIDE TRAILER	96	24	48
15-1225	TRAILER BULKHEAD 10" RETURN FOR 102" WIDE TRAILER	96	10	48
15-1230	TRAILER BULKHEAD 24" RETURN FOR 102" WIDE TRAILER	96	24	48
CAB RACK, ENCLOSURE AND DROM PRODUCT CONFIGURED OPTIONS		W"	D"	H"
WINDOW ASSEMBLIES INSTALLED-TO-ORDER		W"	D"	H"
10-5000	WINDOW ASSEMBLY; HIGH-MOUNT, 27"Wx18"H BAR-STYLE WINDOW	27	2	18
10-5000-LVR	WINDOW ASSEMBLY; HIGH-MOUNT 27"Wx18"H LOUVER-STYLE WINDOW	27	2	18
10-5005	WINDOW ASSEMBLY; 27"Wx-18"H LOUVER-STYLE WINDOW INSTALL AT CENTER LINE 51" ABOVE FRAME-TOP	27	2	18

WINDOW ASSEMBLIES INSTALLED-TO-ORDER (Continued)		W"	D"	H"
10-5010	WINDOW ASSEMBLY; HIGH-MOUNT, 27"Wx18"H EXPANABLE MESH-STYLE	27	2	18
10-5020	WINDOW ASSEMBLY; HIGH-MOUNT, BAR-STYLE WINDOW, 70" FULL-WIDTH INSTALL	70	2	18
10-5030	WINDOW ASSEMBLY; HIGH-MOUNT, BAR-STYLE WINDOW, 86" FULL-WIDTH INSTALL	86	2	18
ENCLOSURE SHELVES INSTALLED-TO-ORDER		W"	D"	H"
10-2515C	ENCLOSURE SHELF INSTALLATION; 14" SHELF FOR 10-1150; CENTER BOX INSTALLATION	29.5	14.625	1.125
10-2515L	ENCLOSURE SHELF INSTALLATION; 14" SHELF FOR 10-1150; LEFT BOX INSTALLATION	28	14.625	1.125
10-2515R	ENCLOSURE SHELF INSTALLATION; 14" SHELF FOR 10-1150; RIGHT BOX INSTALLATION	28	14.625	1.125
CAB RACK TOOLBOX INSTALLED-TO-ORDER		W"	D"	H"
10-2401	SLOPED DIAMOND PLATE LID, ALUMINUM TOOL BOX, INSTALLED ON CAB RACK AT TIME OF ORDER	24	25	18
10-2401S	SLOPED, SMOOTH LID ALUMINUM TOOL BOX, INSTALLED ON CAB RACK AT TIME OF ORDER	24	25	18
LOAD LOCK CARRIERS		W"	D"	H"
35-5504	2-BAR LOAD LOCK CARRIER; SINGLE CLAMP	10	5	4
35-5505	4-BAR LOAD LOCK CARRIER; SINGLE CLAMP	16	5	4
35-5509	2-BAR LOAD LOCK CARRIER; VERTICAL MOUNT; SINGLE CLAMP WITH BOOT	10	5	4
35-5509-10	2-BAR LOAD LOCK CARRIER TRAY ASSEMBLY; NOT INSTALLED	10	5	4
35-5510	4-BAR LOAD LOCK CARRIER; VERTICAL MOUNT; SINGLE CLAMP W/BOOT	16	5	4
35-5510-10	4-BAR LOAD LOCK CARRIER TRAY ASSEMBLY; NOT INSTALLED	16	5	4
35-5514	2-BAR LOAD LOCK CARRIER; HORIZONTAL MOUNT; DUAL CLAMP	10	5	4
35-5515	4-BAR LOAD LOCK CARRIER; HORIZONTAL MOUNT; DUAL CLAMP	16	5	4
LIGHTS, LIGHT BARS AND LIGHT BRACKETS		W"	D"	H"
10-4420	OVAL, SEALED BEAM LIGHT ASSEMBLY - STOP/TAIL/TURN			
10-4425	ROUND, LIGHT ASSEMBLY - STOP/TAIL/TURN			

CAB RACKS / CAB RACK ENCLOSURES / DROMS

LIGHTS, LIGHT BARS AND LIGHT BRACKETS (Continued)		W"	D"	H"
10-4450	BRACKET, BEACON LIGHT BRACKET, 8 INCH DIAMETER, 7 INCHES TALL			
10-4458	BRACKET, BEACON LIGHT MOUNTING 12 INCHES X 18 INCHES			
10-9000	LOAD LIGHT BRACKET, WELD-ON STYLE INSTALLED, 2.5 INCHES X 2.5 INCHES			
10-9010	LOAD LIGHT BRACKET, BOLT-ON STYLE, 6.5 INCHES X 3 INCHES			
10-9419	ANGLE MOUNTING BRACKET; 1 HOLE @ 1-1/2 OUT GALVANIZED, 2.25 INCHES X 3.25 INCHES			
10-9433	BRACKET, SINGLE BOLT MTG. GALVANIZED, 3.25 INCHES X 2.125 INCHES			
35-4470	ALUMINUM LIGHT BAR, FRAME MOUNT, 2 HOLES, 5-3/4"H X 12-1/2"W	12.50	3	6
35-4480	LIGHT BAR, FRAME MOUNT, 4 HOLES, 5-3/4"H X 42-1/4"W	42.25	3	6
35-4490	LIGHT BAR, FRAME MOUNT, 6 HOLES, 17"H X 46.7 - 1/2 W	46.70	3	17
90-540900	LOAD LIGHT; SHIPS LOOSE; 4.75 INCH DIAMETER			
10-9009	WIRING, PAIR; LOAD LIGHT BRACKETS			
OTHER CAB RACK ACCESSORIES		W"	D"	H"
10-2700	HOSE RACK; SHIPS LOOSE	34	13	92
10-3500-LID	LID FOR CHAIN TRAY 84"W X 12"D; SHIPS LOOSE	84	12	1
10-3600-LID	LID FOR CHAIN TRAY 64"W X 12"D; SHIPS LOOSE	64	12	1
10-3700-LID	LID FOR CHAIN TRAY 24"W X 12"D; SHIPS LOOSE	24	12	1
10-3800-LID	LID FOR CHAIN TRAY 18"W X 12"D; SHIPS LOOSE	18	12	1
10-4210	OVERLOAD WOOD SIGN; INSTALLED ON AIR-ACTUATED SIGN BRACKET	85	3	18
11-4210	OVERLOAD WOOD SIGN ON AIR-ACTUATED SIGN BRACKET NOT INSTALLED	85	3	18
10-5200	GRAB HANDLE, WELD-ON	0.8	3	25
11-5200	GRAB HANDLE; SHIPS LOOSE	0.8	3	25
10-5620	AXE & SHOVEL HOLDER; INSTALLED	12	2	1
10-7000	TIE-DOWN WINCH; STEEL; BOLT-ON; INSTALLED			
11-7000	TIE-DOWN WINCH; BOLT-ON STEEL DRILL ONLY			
10-7010	STRAP HOOK - 0.75"; MILD STEEL INSTALLED	0.75	3	32
10-7015	ROPE HOOK - 0.50"; ALUMINUM INSTALLED	0.5	2	2
11-4460	CHANNEL LIGHT BAR; TWO UPRIGHTS, FLAT MOUNTING SURFACE; SHIPS LOOSE	48	8.5	32.5

OTHER CAB RACK ACCESSORIES (Continued)		W"	D"	H"
35-4300	HOSE TENDER FOR AIR/ELECTRICAL; STAINLESS STEEL; X-FRAME	32	6	4
35-9943	HOSE TENDER MOUNTING KIT	3	2	6.3
CHAIN HANGERS INSTALLED-TO-ORDER		W"	D"	H"
10-590	CHAIN HANGER; TOP-OPEN LOCKABLE DIAMOND PLATE COVER; INSTALLED	17.5	4.3	4.5
10-5903B	CHAIN HANGER; TOP-OPEN LOCKABLE SMOOTH, BUFF LID, INSTALLED	17.5	4.3	4.5
10-5903S	CHAIN HANGER; TOP-OPEN; LOCKABLE SMOOTH, MILL FINISH COVER; INSTALLED	17.5	4.3	4.5
10-5903NL	CHAIN HANGER; NO LID; TYPICALLY FOR ENCLOSURES	17.5	4.3	4.5
CHAIN TRAYS INSTALLED-TO-ORDER		W"	D"	H"
10-3315	CAB RACK CHAIN TRAY; CENTER RECESSED PANEL; INSTALLED	26.38	5	28.5
10-3400	CAB RACK CHAIN TRAY; BASE MOUNT; INSTALLED	30	20	3
10-3500	CAB RACK CHAIN TRAY; FOR 90"W CAB RACK; INSTALLED	83	12	12
10-3501	CAB RACK CHAIN TRAY; FOR 90"W CAB RACKS; INSTALLED	86	9	9
10-3503	CAB RACK CHAIN TRAY; FOR 86"W CAB RACK; INSTALLED	80	12	10
10-3508	CAB RACK CHAIN TRAY; FOR 86"W CAB RACKS; INSTALLED	82	9	9
10-3510	CAB RACK CHAIN TRAY; FOR 90" W CAB RACKS; INSTALLED	84	8	7.5
10-3518	CAB RACK CHAIN TRAY; FOR 86"W CAB RACKS; INSTALLED	80	8	7.5
10-3521	CAB RACK CHAIN TRAY; FOR 82"W CAB RACK; INSTALLED	78	9	7.5
10-3540	CAB RACK CHAIN TRAY; FOR 80"W CAB RACK; INSTALLED	74	12	10
10-3541	CAB RACK CHAIN TRAY; FOR 80"W CAB RACK; INSTALLED	76.25	9	9
10-3548	CAB RACK CHAIN TRAY; FOR 80"W CAB RACK; INSTALLED	74	8	7.5
10-3600	CAB RACK CHAIN TRAY; FOR 70"W CAB RACK; INSTALLED	64	12	10
10-3601	CAB RACK CHAIN TRAY; FOR 70"W CAB RACK; INSTALLED	66	9	9
10-3610	CAB RACK CHAIN TRAY; FOR 70"W CAB RACK; INSTALLED	64	8	7.5

MEDIUM-DUTY TO CLASS-8

CHAIN TRAYS INSTALLED-TO-ORDER (Continued)		W"	D"	H"
10-3700	CAB RACK CHAIN TRAY; INSTALLED	24	12	10
10-3710	CAB RACK CHAIN TRAY; INSTALLED	24	8	25
10-3800	CAB RACK CHAIN TRAY; INSTALLED	18	12	10
10-3810	CAB RACK CHAIN TRAY; INSTALLED	18	8	18
10-3450	DROM CAB RACK CHAIN TRAY; INSTALLED	96	9	8
10-3452	DROM CAB RACK CHAIN TRAY; INSTALLED	90	12	10
10-3454	DROM CAB RACK CHAIN TRAY; INSTALLED	86	12	10
10-3456	DROM CAB RACK CHAIN TRAY; INSTALLED	80	12	10
10-3458	DROM CAB RACK CHAIN TRAY; INSTALLED	70	12	10
10-3420	TOP TARP TRAY, TOP MOUNTED	64	3	15
CHAIN HANGERS FOR CAB RACKS SOLD INDIVIDUALLY		W"	D"	H"
11-5903	CAB RACK MOUNT CHAIN HANGER; TOP-OPEN LOCKABLE DIAMOND PLATE COVER; SHIPS LOOSE	17.5	4.3	4.5
11-5903B	CAB RACK MOUNT CHAIN HANGER; TOP-OPEN LOCKABLE, SMOOTH, BUFF COVER; SHIPS LOOSE	17.5	4.3	4.5
11-5903S	CAB RACK MOUNT CHAIN HANGER, SMOOTH MILL FINISH COVER; SHIPS LOOSE	17.5	4.3	4.5
11-5903NL	CAB RACK MOUNT CHAIN HANGER, NO LID; SHIPS LOOSE	17.5	4.3	4.5
CHAIN TRAYS — SOLD INDIVIDUALLY		W"	D"	H"
10-3520	CHAIN TRAY, RETROFIT, FOR 82"W CAB RACK; SHIPS LOOSE	78	9	7.5
11-3450	DROM CAB RACK CHAIN TRAY; SHIPS LOOSE	96	9	8
11-3500	CAB RACK CHAIN TRAY; FOR 90"W CAB RACK; SHIPS LOOSE	83	12	12
11-3503	CAB RACK CHAIN TRAY, 12"W FOR 86"W CAB RACKS; SHIPS LOOSE	80	12	10
11-3510	CAB RACK CHAIN TRAY, 8"W FOR 90"W CAB RACKS; SHIPS LOOSE	84	8	7.5
11-3518	CAB RACK CHAIN TRAY, 8"W FOR 86"W CAB RACKS; SHIPS LOOSE	80	8	7.5
11-3540	CAB RACK CHAIN TRAY, 12"W FOR 80"W CAB RACKS; SHIPS LOOSE	74	12	10
11-3548	CAB RACK CHAIN TRAY, 8"W FOR 80"W CAB RACKS; SHIPS LOOSE	74	8	7.5

CHAIN TRAYS — SOLD INDIVIDUALLY (Continued)		W"	D"	H"
11-3600	CAB RACK CHAIN TRAY, 12"W FOR 70"W CAB RACKS; SHIPS LOOSE	64	12	10
11-3610	CAB RACK CHAIN TRAY, 8"W FOR 70"W CAB RACKS; SHIPS LOOSE	64	8	7.5
11-3700	CAB RACK CHAIN TRAY; SHIPS LOOSE	24	12	10
11-3710	CAB RACK CHAIN TRAY; SHIPS LOOSE	24	8	25
11-3800	CAB RACK CHAIN TRAY; SHIPS LOOSE	18	12	10
11-3810	CAB RACK CHAIN TRAY; SHIPS LOOSE	18	8	18

FRAME-MOUNT PRODUCTS

FRAME-MOUNTED CHAIN HANGERS

Available in 4-hole, 8-hole and 12-hole bolt patterns with or without covers. Covers are offered with a diamond plate center pivot cover as well as removable and lock-loop or hinged covers in diamond plate or smooth finishes. Holds 1 pair of chains (which is one side of the truck).



HINGED COVER CHAIN HANGERS

SHOWN: 35-5951 Hinged, diamond plate cover; 4-hole base



REMOVABLE COVER CHAIN HANGERS

SHOWN: 35-5950 Removable diamond plate cover; 4-hole base



TRUCK TYPE CHAIN HANGERS

SHOWN: 35-5962GH Freightliner 12-hole base, with center lock bar. Comes without cover.

FRAME MOUNT PRODUCTS

FRAME-MOUNT CHAIN HANGERS SOLD INDIVIDUALLY		W"	D"	H"
35—5911	FRAME-MOUNT CHAIN HANGER; REMOVABLE, DIAMOND PLATE COVER; 4-HOLE BASE	9.25	18.6	9.25
35—5911FL	FRAME-MOUNT CHAIN HANGER; FREIGHTLINER; REMOVABLE, DIAMOND PLATE COVER; 8-HOLE BASE	9.25	18.6	9.25
35—5918	FRAME-MOUNT CHAIN HANGER; HINGED, DIAMOND PLATE COVER; 4-HOLE BASE	9.25	18.6	9.25
35—5918FL	FRAME-MOUNT CHAIN HANGER; FREIGHTLINER; HINGED, DP COVER; 8-HOLE BASE	9.25	18.6	9.25
35—5918FLNL	FRAME-MOUNT CHAIN HANGER; FREIGHTLINER; NO COVER; 8-HOLE BASE	7.75	18.6	9.25
35—5950	FRAME-MOUNT CHAIN HANGER; REMOVABLE DIAMOND PLATE COVER; 4-HOLE BASE	9.25	24.5	9.25
35—5950FL	FRAME-MOUNT CHAIN HANGER; FREIGHTLINER; REMOVABLE DP COVER; 8-HOLE BASE	9.25	24.5	9.25
35—5950KW	FRAME-MOUNT CHAIN HANGER; KENWORTH; REMOVABLE DP COVER; 4-HOLE BASE	9.25	24.5	9.38
35—5950KWCP	FRAME-MOUNT CHAIN HANGER; KENWORTH; REMOVABLE DP COVER; CHAIN PIN; 4-HOLE BASE	9.25	24.75	9.38
35—5950NL	FRAME-MOUNT CHAIN HANGER; NO COVER; 4-HOLE BASE	7.75	24.5	9.25
35—5950S	FRAME-MOUNT CHAIN HANGER; REMOVABLE SMOOTH COVER; 4-HOLE BASE	9.25	24.5	9.25
35—5951	FRAME-MOUNT CHAIN HANGER; HINGED DIAMOND PLATE COVER; 4-HOLE BASE	9.25	24.6	9.26
35—5951FL	FRAME-MOUNT CHAIN HANGER; FREIGHTLINER; HINGED DP COVER; 8-HOLE BASE	9.25	24.6	9.27
35—5951KW	FRAME-MOUNT CHAIN HANGER; KENWORTH; HINGED DP COVER; 4-HOLE BASE	9.25	24.6	9.28
35—5951S	FRAME-MOUNT CHAIN HANGER; HINGED SMOOTH COVER; 4-HOLE BASE	9.25	24.6	9.29
35—5962	FRAME-MOUNT CHAIN HANGER; NO COVER; CENTER LOCK BAR; 8-HOLE BASE	9.25	24.4	9.38
35—5962GH	FRAME-MOUNT CHAIN HANGER; NO COVER; CENTER LOCK BAR; 12-HOLE BASE	9.25	24.4	9.38
35—5975	FRAME-MOUNT CHAIN HANGER; CENTER PIVOT DIAMOND PLATE COVER; 8-HOLE BASE	8.75	24.4	9.13

ALUMINUM GRATE DECK COVERS

Self-draining, 4-way grip, 34" deep and includes mounting hardware.

ALUMINUM DIAMOND PLATE DECK COVERS

Hidden mount, 34" deep — with or without stiffeners — and mounting hardware is included. In 2, 3, 4, 5, 6, 7, 8 and 9 foot widths

ALUMINUM GRIP STRUT® DECK COVERS

Self-draining deck covers in 2,3,4,5 and 6 foot widths, 34" deep and 1" high. Includes mounting hardware. Meets requirement for walk surface.

FRAME-MOUNT ALUMINUM STEPS

Steps are 24" high and available in three widths 12", 18" and 24" with 4-way grip steps. Universal mounting.

DECK INSTALLATION

Deck plate installation starts with a stiffener placed on the bottom of the deck plate. A slot in the stiffener allows the head of the bolt to be held captive while the threaded portion of the bolt goes through the mounting deck clamp and is held by a washer and nut.

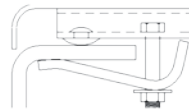

ALUMINUM FRAME MOUNT STEPS

SHOWN: 35-5260 Universal mount, 4-way Grip Strut® step 18"W x 13.5"D x 24"H



ALUMINUM DIAMOND PLATE DECK COVERS

SHOWN: 35-5440 IS 48"W x 34"D x 1"H, with stiffeners and mounting kit.



GRATE-STYLE FRAME DECK COVERS

SHOWN: 35-5400 Self-draining, aluminum bar grate-style cover 36"W x 34"D x 1"H. Includes mounting kit.



GRIP STRUT® FRAME DECK COVERS —

SHOWN: 35-5425 includes mounting kit; 24"W x 34"D x 2.5"H; Meets requirement for walking surface.

MEDIUM-DUTY TO CLASS-8

FRAME MOUNT PRODUCTS

FRAME DECK COVERS		W"	D"	H"
35-5320	FRAME DECK COVER: DIAMOND PLATE; ALUMINUM; NO STIFFENER	24	34	1
35-5330	FRAME DECK COVER: DIAMOND PLATE; ALUMINUM; NO STIFFENER	36	34	1
35-5340	FRAME DECK COVER: DIAMOND PLATE; ALUMINUM; NO STIFFENER	48	34	1
35-5350	FRAME DECK COVER: DIAMOND PLATE; ALUMINUM; NO STIFFENER	60	34	1
35-5360	FRAME DECK COVER: DIAMOND PLATE; ALUMINUM; NO STIFFENER	72	34	1
35-5370	FRAME DECK COVER: DIAMOND PLATE; ALUMINUM; NO STIFFENER	84	34	1
35-5380	FRAME DECK COVER: DIAMOND PLATE; ALUMINUM; NO STIFFENER	96	34	1
35-5390	FRAME DECK COVER: DIAMOND PLATE; ALUMINUM; NO STIFFENER	108	34	1
35-5395	FRAME DECK COVER: DIAMOND PLATE; ALUMINUM; NO STIFFENER	120	34	1
35-5408	FRAME DECK COVER; DIAMOND PLATE ALUMINUM; STAINLESS STEEL FASTENERS; WITH STIFFENERS	18	34	1
35-5420	FRAME DECK COVER: DIAMOND PLATE; ALUMINUM; WITH STIFFENERS; INCLUDES MOUNTING KIT	24	34	1
35-5430	FRAME DECK COVER: DIAMOND PLATE; ALUMINUM; WITH STIFFENERS; INCLUDES MOUNTING KIT	36	34	1
35-5440	FRAME DECK COVER: DIAMOND PLATE; ALUMINUM; WITH STIFFENERS; INCLUDES MOUNTING KIT	48	34	1
35-5450	FRAME DECK COVER: DIAMOND PLATE; ALUMINUM; WITH STIFFENERS; INCLUDES MOUNTING KIT	60	34	1
35-5460	FRAME DECK COVER: DIAMOND PLATE; ALUMINUM; WITH STIFFENERS; INCLUDES MOUNTING KIT	72	34	1
35-5470	FRAME DECK COVER: DIAMOND PLATE; ALUMINUM; WITH STIFFENERS; INCLUDES MOUNTING KIT	84	34	1
35-5480	FRAME DECK COVER: DIAMOND PLATE; ALUMINUM; WITH STIFFENERS; INCLUDES MOUNTING KIT	96	34	1
35-5490	FRAME DECK COVER: DIAMOND PLATE; ALUMINUM; WITH STIFFENERS; INCLUDES MOUNTING KIT	108	34	1
35-5495	FRAME DECK COVER: DIAMOND PLATE; ALUMINUM; WITH STIFFENERS; INCLUDES MOUNTING KIT	120	34	1
35-5400	FRAME DECK COVER; ALUMINUM BAR GRATE-STYLE; INCLUDES MOUNTING KIT [N.B. Meets requirements for walking surface]	36	34	1
35-5425	FRAME DECK COVER; GRIP STRUT®; INCLUDES MOUNTING KIT [N.B. Meets requirements for walking surface]	24	34	2.5

FRAME DECK COVERS (Continued)		W"	D"	H"
35-5435	FRAME DECK COVER; GRIP STRUT®; INCLUDES MOUNTING KIT [N.B. Meets requirements for walking surface]	36	34	2.5
35-5445	FRAME DECK COVER; GRIP STRUT®; INCLUDES MOUNTING KIT [N.B. Meets requirements for walking surface]	48	34	2.5
35-5455	FRAME DECK COVER; GRIP STRUT®; INCLUDES MOUNTING KIT [N.B. Meets requirements for walking surface]	60	34	2.5
35-5465	FRAME DECK COVER; GRIP STRUT®; INCLUDES MOUNTING KIT [N.B. Meets requirements for walking surface]	72	34	2.5
FRAME DECK COVER MOUNTING KITS SOLD INDIVIDUALLY		W"	D"	H"
35-9900	MOUNTING KIT FOR DIAMOND PLATE FRAME DECK COVERS UP TO 48"W; SHIPS LOOSE			
35-9905	MOUNTING KIT FOR DIAMOND PLATE FRAME DECK COVERS, OVER 48"W; SHIPS LOOSE			
35-9910	MOUNTING KIT ALUMINUM BAR GRATE-STYLE FRAME DECK COVERS; SHIPS LOOSE			
35-9922	MOUNTING KIT FOR GRIP STRUT® STYLE DECK COVERS; SHIPS LOOSE			
FRAME STEPS		W"	D"	H"
35-5225	FRAME MOUNT STEP FOR DROM; ALUMINUM; SHIPS LOOSE	12	5	26
35-5250	FRAME MOUNT STEP; ALUMINUM; SHIPS LOOSE	12	13.5	24
35-5260	FRAME MOUNT STEP; ALUMINUM; SHIPS LOOSE	18	13.5	24
35-5270	FRAME MOUNT STEP; ALUMINUM; SHIPS LOOSE	24	13.5	24



ALUMINUM STORAGE BOXES

PROTECH STEEL AND ALUMINUM STORAGE BOXES. SECURE. WEATHER RESISTANT.

Rugged ProTech storage boxes are offered in aluminum or steel and available in 31 standard sizes in 18" and 24" depths, from 18" to 72" wide. There are also six configurations of 15"Hx15"D boxes in 18", 24" and 30" widths. If that's not what you need, we'll make it. Any size. Any style.

FEATURES

ALUMINUM TOOLBOXES

Constructed of heavy, 5052 marine-grade aluminum, typically used for boat hulls and truck bodies, delivers the equivalent deflection strength of steel with significant weight savings and durability.



KEY POINTS

- Continuous seam MIG welds on chest's stress panels, such as box floor
- Full-length stainless steel piano hinges on doors and lids
- Double-swing door T-lock faces towards cab
- Double-swing doors available on 36"W or wider boxes
- Stainless steel T-handle keyed latches — can be keyed alike
- Toolboxes can be ordered with combinations of materials and finishes:
 - Stainless steel
 - Buffed Aluminum
 - Diamond plate
 - Mill finish
- Replacement parts are available



STORAGE BOX 20-2410S

Aluminum frame-mount box with a 20" to 15" slope-top, buffed X-shape cross-break top open lid and keyed, stainless steel T-handle lock



FULL LENGTH STAINLESS STEEL PIANO HINGE

On doors and lids for rigidity and water tightness

NEOPRENE, AUTOMOTIVE BULB SEALS

On compartment openings



SMOOTH TRANSITION TIG WELDS

Used on all visible corners

STANDARD POWDER COAT COLORS



BLACK WHITE

While white or black are standard colors, boxes can be ordered to match paint codes

CLAIBORNE HAULING

Custom ProTech back pack for owner's personal vehicle



MEDIUM-DUTY TO CLASS-8

ALUMINUM STORAGE BOXES

ALUMINUM TOOLBOXES

All aluminum toolbox bodies are 0.125" 5052 marine grade aluminum in mill finish. Doors and lids are available in aluminum diamond plate, polished or mill finish aluminum and stainless steel.

On double-swing door boxes, it is necessary to specify drivers side (L) or passenger (R) placement. Simply add the letter to the part number.

TOOLBOX FRAME MOUNTING KITS

Kits are black powder coated steel and installed with the longer leg placed vertically.

20-9710: BRACKETS FOR 18" DEEP BOX

20-9700: BRACKETS FOR 24" DEEP BOX

20-9720: BRACKETS FOR 30" DEEP BOX

ALUMINUM STEP BOXES

These complete units provide storage space in a smooth aluminum body with Grip Strut® stair-tread and diamond plate or smooth doors. Standard dimensions: 25"H x 24"D and widths of 12"W, 18"W and 24"W boxes have built-in mounting brackets. External brackets are required for 30" W and 36"W box installation. Custom sizes, as well as boxes without steps, are available.

CAB ENTRY BOXES

Features bulb seal, weather-resistant boxes with replaceable Grip Strut® tread assembly. Heights are 15"H and 18"H. Depths are 25"D and 30"D. Widths are 24"W, 31"W and 36"W. Cab entry boxes require a mounting bracket kit (20-9751).

ALUMINUM BATTERY BOX

Not sealed. Battery cable opening is rear-entry. Available with or without steps. Mounting brackets are available for the battery box.

IN-FRAME TOOLBOX

Fully sealed box rests on frame rail top; includes mounting clips and bolts for frame mounting. Available in two widths in 8"H or 10"H heights.



IN-FRAME TOOLBOXES

SHOWN: 20-2647 Mill finish aluminum in-frame toolbox; diamond plate cover; bulb seals; hasp lock; includes mounting kit 30"W x 22"D x 8"H



DROP-DOWN DOOR BOXES

SHOWN: 20-2070 Polished, 0.112 aluminum, single drop-down door with locking T-handle. 24"W x 18"D x 18"H. Also available with diamond plate (D) or stainless steel door (S) and side swing door (L) (R).



SIDE SWING DOOR BOXES

SHOWN: 20-2214L Polished, 0.112 aluminum, double side swing doors; left-door locking T-handle. 48"W x 24"D x 24"H. Also available with diamond plate (D) door and side swing door (R).



DROP-DOWN DOOR BOXES

SHOWN: 20-2190D Diamond plate, 0.105" aluminum, single, drop-down door with locking T-handle — 36"W x 24"D x 18"H. Also available with polished (20-2190), or stainless steel (S) door or side swing doors (L) (R)



STEP BOXES

SHOWN: 20-2470 Aluminum step box with .105 diamond plate aluminum lid; Grip Strut® step; bulb seals; stainless steel keyed T-lock; internal brackets. 24"W x 28"D x 25"D. Also available with polished aluminum lid (20-2470S), or stainless steel (S).



CAB ENTRY BOXES

SHOWN: 20-2911-24 Aluminum cab entry box; Grip Strut® steps; full hinge, up-swing diamond plate lid, bulb seals; stainless steel keyed T-lock; 31"W x 30"D x 15"H. Brackets not included.



BATTERY BOXES

SHOWN: 20-2959 Aluminum battery box; Grip Strut® steps, top and bottom; removable, diamond plate cover; 30"W x 30"D x 15"H. Brackets not included.

ALUMINUM STORAGE BOXES

ALUMINUM BACK PACK BOXES		W"	D"	H"
20-2712	BACK PACK BOX, NOTCHED FLOOR; SMOOTH DOORS	84	24	56
20-2714	BACK PACK BOX; FLAT FLOOR; SMOOTH DOORS	84	24	56
20-2717	BACK PACK BOX; FLAT FLOOR; STAINLESS DOORS	84	24	56
20-2732	BACK PACK BOX; NOTCHED FLOOR; DIAMOND PLATE DOORS	84	24	56
20-2734	BACK PACK BOX; FLAT FLOOR; DIAMOND PLATE DOORS	84	24	56
20-2737	BACK PACK BOX, NOTCHED FLOOR; STAINLESS DOORS	84	24	56
ALUMINUM STORAGE & TOOLBOXES		W"	D"	H"
20-2004	ALUMINUM BOX, MILL FINISH .125 BODY; SMOOTH, .112 ALUMINUM SINGLE DROP-DOWN DOOR; LOCKING T-HANDLE; LOCKING T-HANDLE	24	24	24
20-2004D	ALUMINUM BOX, MILL FINISH .125 BODY; DIAMOND PLATE, .105 ALUMINUM, .105 ALUMINUM, SINGLE DROP-DOWN DOOR; LOCKING T-HANDLE	24	24	24
20-2004DL	ALUMINUM BOX, MILL FINISH .125 BODY; DIAMOND PLATE, .105 ALUMINUM, SINGLE LEFT-HAND SIDE-SWING DOOR; LOCKING T-HANDLE	24	24	24
20-2004DR	ALUMINUM BOX, MILL FINISH .125 BODY; DIAMOND PLATE, .105 ALUMINUM, SINGLE RIGHT-HAND SIDE-SWING DOOR; LOCKING T-HANDLE	24	24	24
20-2004L	ALUMINUM BOX, MILL FINISH .125 BODY; SMOOTH, .112 ALUMINUM SINGLE LEFT-HAND SIDE-SWING DOOR; LOCKING T-HANDLE	24	24	24
20-2004R	ALUMINUM BOX, MILL FINISH .125 BODY; SMOOTH, .112 ALUMINUM SINGLE RIGHT-HAND SIDE-SWING DOOR; LOCKING T-HANDLE	24	24	24
20-2004SS	ALUMINUM BOX, MILL FINISH .125 BODY; STAINLESS STEEL, SINGLE DROP-DOWN DOOR; LOCKING T-HANDLE	24	24	24
20-2005	ALUMINUM BOX, MILL FINISH .125 BODY; SMOOTH, .112 ALUMINUM SINGLE DROP-DOWN DOOR; LOCKING T-HANDLE	30	24	24
20-2005D	ALUMINUM BOX, MILL FINISH .125 BODY; DIAMOND PLATE, .105 ALUMINUM, SINGLE DROP-DOWN DOOR; LOCKING T-HANDLE	30	24	24
20-2005DL	ALUMINUM BOX, MILL FINISH .125 BODY; DIAMOND PLATE, .105 ALUMINUM, SINGLE LEFT-HAND SIDE-SWING DOOR; LOCKING T-HANDLE	30	24	24
20-2005DR	ALUMINUM BOX, MILL FINISH .125 BODY; DIAMOND PLATE, .105 ALUMINUM, SINGLE RIGHT-HAND SIDE-SWING DOOR; LOCKING T-HANDLE	30	24	24
20-2005L	ALUMINUM BOX, MILL FINISH .125 BODY; SMOOTH, .112 ALUMINUM SINGLE LEFT-HAND SIDE-SWING DOOR; LOCKING T-HANDLE	30	24	24
20-2005R	ALUMINUM BOX, MILL FINISH .125 BODY; SMOOTH, .112 ALUMINUM SINGLE RIGHT-HAND SIDE-SWING DOOR; LOCKING T-HANDLE	30	24	24

ALUMINUM STORAGE & TOOLBOXES (Continued)		W"	D"	H"
20-2005SS	ALUMINUM BOX, MILL FINISH .125 BODY; STAINLESS STEEL SINGLE DROP-DOWN DOOR; LOCKING T-HANDLE	30	24	24
20-2013	ALUMINUM BOX, MILL FINISH .125 BODY; SMOOTH, .112 ALUMINUM SINGLE DROP-DOWN DOOR; LOCKING T-HANDLE	18	15	15
20-2013D	ALUMINUM BOX, MILL FINISH .125 BODY; DIAMOND PLATE, .105 ALUMINUM, SINGLE DROP-DOWN DOOR; LOCKING T-HANDLE	18	15	15
20-2013S	ALUMINUM BOX, MILL FINISH .125 BODY; SMOOTH, .112 ALUMINUM SINGLE SIDE-SWING DOOR; LOCKING T-HANDLE; SPECIFY LEFT or RIGHT SWING.	18	15	15
20-2015	ALUMINUM BOX, MILL FINISH .125 BODY; SMOOTH, .112 ALUMINUM SINGLE DROP-DOWN DOOR; LOCKING T-HANDLE	24	15	15
20-2015D	ALUMINUM BOX, MILL FINISH .125 BODY; DIAMOND PLATE, .105 ALUMINUM, SINGLE DROP-DOWN DOOR; LOCKING T-HANDLE	24	15	15
20-2015S	ALUMINUM BOX, MILL FINISH .125 BODY; SMOOTH, .112 ALUMINUM SINGLE SIDE-SWING DOOR; LOCKING T-HANDLE; SPECIFY LEFT or RIGHT SWING.	24	15	15
20-2017	ALUMINUM BOX, MILL FINISH .125 BODY; SMOOTH, .112 ALUMINUM SINGLE DROP-DOWN DOOR; LOCKING T-HANDLE	30	15	15
20-2017D	ALUMINUM BOX, MILL FINISH .125 BODY; DIAMOND PLATE, .105 ALUMINUM, DROP-DOWN DOOR; LOCKING T-HANDLE	30	15	15
20-2017S	ALUMINUM BOX, MILL FINISH .125 BODY; SMOOTH, .112 ALUMINUM SINGLE SIDE-SWING DOOR; LOCKING T-HANDLE; SPECIFY LEFT or RIGHT SWING.	30	15	15
20-2068	ALUMINUM BOX, MILL FINISH .125 BODY; SMOOTH, .112 ALUMINUM SINGLE DROP-DOWN DOOR; LOCKING T-HANDLE	18	18	18
20-2068D	ALUMINUM BOX, MILL FINISH .125 BODY; DIAMOND PLATE, .105 ALUMINUM, SINGLE DROP-DOWN DOOR; LOCKING T-HANDLE	18	18	18
20-2068DL	ALUMINUM BOX, MILL FINISH .125 BODY; DIAMOND PLATE, .105 ALUMINUM, LEFT-HAND SIDE-SWING DOOR; LOCKING T-HANDLE	18	18	18
20-2068DR	ALUMINUM BOX, MILL FINISH .125 BODY; DIAMOND PLATE, .105 ALUMINUM, RIGHT-HAND SIDE-SWING DOOR; LOCKING T-HANDLE	18	18	18
20-2068L	ALUMINUM BOX, MILL FINISH .125 BODY; SMOOTH, .112 ALUMINUM LEFT-HAND SIDE-SWING DOOR; LOCKING T-HANDLE	18	18	18
20-2068R	ALUMINUM BOX, MILL FINISH .125 BODY; SMOOTH, .112 ALUMINUM RIGHT-HAND SIDE-SWING DOOR; LOCKING T-HANDLE	18	18	18
20-2068SS	ALUMINUM BOX, MILL FINISH .125 BODY; STAINLESS STEEL, SINGLE DROP-DOWN DOOR; LOCKING T-HANDLE	18	18	18

MEDIUM-DUTY TO CLASS-8

ALUMINUM STORAGE & TOOLBOXES (Continued)		W"	D"	H"
20-2070	ALUMINUM BOX, MILL FINISH .125 BODY; SMOOTH, .112 ALUMINUM SINGLE DROP-DOWN DOOR; LOCKING T-HANDLE	24	18	18
20-2070D	ALUMINUM BOX, MILL FINISH .125 BODY; DIAMOND PLATE, .105 ALUMINUM, SINGLE DROP-DOWN DOOR; LOCKING T-HANDLE	24	18	18
20-2070DL	ALUMINUM BOX, MILL FINISH .125 BODY; DIAMOND PLATE, .105 ALUMINUM, SINGLE LEFT-HAND SIDE-SWING DOOR; LOCKING T-HANDLE	24	18	18
20-2070DR	ALUMINUM BOX, MILL FINISH .125 BODY; DIAMOND PLATE, .105 ALUMINUM, SINGLE RIGHT-HAND SIDE-SWING DOOR; LOCKING T-HANDLE	24	18	18
20-2070L	ALUMINUM BOX, MILL FINISH .125 BODY; SMOOTH, .112 ALUMINUM SINGLE LEFT-HAND SIDE-SWING DOOR; LOCKING T-HANDLE	24	18	18
20-2070R	ALUMINUM BOX, MILL FINISH .125 BODY; SMOOTH, .112 ALUMINUM SINGLE RIGHT-HAND SIDE-SWING DOOR; LOCKING T-HANDLE	24	18	18
20-2070SS	ALUMINUM BOX, MILL FINISH .125 BODY; STAINLESS STEEL DROP-DOWN DOOR; LOCKING T-HANDLE	24	18	18
20-2073	ALUMINUM BOX, MILL FINISH .125 BODY; SMOOTH, .112 ALUMINUM SINGLE DROP-DOWN DOOR; LOCKING T-HANDLE	30	18	18
20-2073D	ALUMINUM BOX, MILL FINISH .125 BODY; DIAMOND PLATE, .105 ALUMINUM, SINGLE DROP-DOWN DOOR; LOCKING T-HANDLE	30	18	18
20-2073DL	ALUMINUM BOX, MILL FINISH .125 BODY; DIAMOND PLATE, .105 ALUMINUM, SINGLE LEFT-HAND SIDE-SWING DOOR; LOCKING T-HANDLE	30	18	18
20-2073DR	ALUMINUM BOX, MILL FINISH .125 BODY; DIAMOND PLATE, .105 ALUMINUM, SINGLE RIGHT-HAND SIDE-SWING DOOR; LOCKING T-HANDLE	30	18	18
20-2073L	ALUMINUM BOX, MILL FINISH .125 BODY; SMOOTH, .112 ALUMINUM SINGLE LEFT-HAND SIDE-SWING DOOR; LOCKING T-HANDLE	30	18	18
20-2073R	ALUMINUM BOX, MILL FINISH .125 BODY; SMOOTH, .112 ALUMINUM SINGLE RIGHT-HAND SIDE-SWING DOOR; LOCKING T-HANDLE	30	18	18
20-2073SS	ALUMINUM BOX, MILL FINISH .125 BODY; STAINLESS STEEL, SINGLE DROP-DOWN DOOR; LOCKING T-HANDLE	30	18	18
20-2090	ALUMINUM BOX, MILL FINISH .125 BODY; SMOOTH, .112 ALUMINUM SINGLE DROP-DOWN DOOR; LOCKING T-HANDLE	24	24	18
20-2090D	ALUMINUM BOX, MILL FINISH .125 BODY; DIAMOND PLATE, .105 ALUMINUM, SINGLE DROP-DOWN DOOR; LOCKING T-HANDLE	24	24	18

ALUMINUM STORAGE & TOOLBOXES (Continued)		W"	D"	H"
20-2090DL	ALUMINUM BOX, MILL FINISH .125 BODY; DIAMOND PLATE, .105 ALUMINUM, SINGLE LEFT-HAND SIDE-SWING DOOR; LOCKING T-HANDLE	24	24	18
20-2090DR	ALUMINUM BOX, MILL FINISH .125 BODY; DIAMOND PLATE, .105 ALUMINUM, SINGLE RIGHT-HAND SIDE-SWING DOOR; LOCKING T-HANDLE	24	24	18
20-2090L	ALUMINUM BOX, MILL FINISH .125 BODY; SMOOTH, .112 ALUMINUM SINGLE LEFT-HAND SIDE-SWING DOOR; LOCKING T-HANDLE	24	24	18
20-2090R	ALUMINUM BOX, MILL FINISH .125 BODY; SMOOTH, .112 ALUMINUM SINGLE RIGHT-HAND SIDE-SWING DOOR; LOCKING T-HANDLE	24	24	18
20-2093	ALUMINUM BOX, MILL FINISH .125 BODY; SMOOTH, .112 ALUMINUM SINGLE DROP-DOWN DOOR; LOCKING T-HANDLE	30	24	18
20-2093D	ALUMINUM BOX, MILL FINISH .125 BODY; DIAMOND PLATE, .105 ALUMINUM, SINGLE DROP-DOWN DOOR; LOCKING T-HANDLE	30	24	18
20-2093DL	ALUMINUM BOX, MILL FINISH .125 BODY; DIAMOND PLATE, .105 ALUMINUM, SINGLE LEFT-HAND SIDE-SWING DOOR; LOCKING T-HANDLE	30	24	18
20-2093DR	ALUMINUM BOX, MILL FINISH .125 BODY; DIAMOND PLATE, .105 ALUMINUM, SINGLE RIGHT-HAND SIDE-SWING DOOR; LOCKING T-HANDLE	30	24	18
20-2093L	ALUMINUM BOX, MILL FINISH .125 BODY; SMOOTH, .112 ALUMINUM SINGLE LEFT-HAND SIDE-SWING DOOR; LOCKING T-HANDLE	30	24	18
20-2093R	ALUMINUM BOX, MILL FINISH .125 BODY; SMOOTH, .112 ALUMINUM SINGLE RIGHT-HAND SIDE-SWING DOOR; LOCKING T-HANDLE	30	24	18
20-2104	ALUMINUM BOX, MILL FINISH .125 BODY; SMOOTH, .112 ALUMINUM SINGLE DROP-DOWN DOOR; LOCKING T-HANDLE	36	24	24
20-2104D	ALUMINUM BOX, MILL FINISH .125 BODY; DIAMOND PLATE, .105 ALUMINUM, SINGLE DROP-DOWN DOOR; LOCKING T-HANDLE	36	24	24
20-2104DL	ALUMINUM BOX, MILL FINISH .125 BODY; DIAMOND PLATE, .105 ALUMINUM, SINGLE LEFT-HAND SIDE-SWING DOOR; LOCKING T-HANDLE	36	24	24
20-2104DR	ALUMINUM BOX, MILL FINISH .125 BODY; DIAMOND PLATE, .105 ALUMINUM, SINGLE RIGHT-HAND SIDE-SWING DOOR; LOCKING T-HANDLE	36	24	24
20-2104L	ALUMINUM BOX, MILL FINISH .125 BODY; SMOOTH, .112 ALUMINUM SINGLE LEFT-HAND SIDE-SWING DOOR; LOCKING T-HANDLE	36	24	24
20-2104R	ALUMINUM BOX, MILL FINISH .125 BODY; SMOOTH, .112 ALUMINUM SINGLE RIGHT-HAND SIDE-SWING DOOR; LOCKING T-HANDLE	36	24	24

ALUMINUM STORAGE BOXES

ALUMINUM STORAGE & TOOLBOXES (Continued)		W"	D"	H"
20-2104SS	ALUMINUM BOX, MILL FINISH .125 BODY; STAINLESS STEEL, SINGLE DROP-DOWN DOOR; LOCKING T-HANDLE	36	24	24
20-2112L	ALUMINUM BOX, MILL FINISH .125 BODY; SMOOTH, .112 ALUMINUM DOUBLE SIDE-SWING DOORS; LEFT-DOOR LOCKING T-HANDLE	36	24	24
20-2112R	ALUMINUM BOX, MILL FINISH .125 BODY; SMOOTH, .112 ALUMINUM DOUBLE SIDE-SWING DOORS; RIGHT-DOOR LOCKING T-HANDLE	36	24	24
20-2114DL	ALUMINUM BOX, MILL FINISH .125 BODY; DIAMOND PLATE, .105 ALUMINUM, DOUBLE SIDE-SWING DOORS; LEFT-DOOR LOCKING T-HANDLE	36	24	24
20-2114DR	ALUMINUM BOX, MILL FINISH .125 BODY; DIAMOND PLATE, .105 ALUMINUM, DOUBLE SIDE-SWING DOORS; RIGHT-DOOR LOCKING T-HANDLE	36	24	24
20-2114L	ALUMINUM BOX, MILL FINISH .125 BODY; SMOOTH, .112 ALUMINUM DOUBLE SIDE-SWING DOORS; LEFT-DOOR LOCKING T-HANDLE	36	24	24
20-2114R	ALUMINUM BOX, MILL FINISH .125 BODY; SMOOTH, .112 ALUMINUM DOUBLE SIDE-SWING DOORS; RIGHT-DOOR LOCKING T-HANDLE	36	24	24
20-2170	ALUMINUM BOX, MILL FINISH .125 BODY; SMOOTH, .112 ALUMINUM SINGLE DROP-DOWN DOOR; LOCKING T-HANDLE	36	18	18
20-2170D	ALUMINUM BOX, MILL FINISH .125 BODY; DIAMOND PLATE, .105 ALUMINUM, SINGLE DROP-DOWN DOOR; LOCKING T-HANDLE	36	18	18
20-2170DL	ALUMINUM BOX, MILL FINISH .125 BODY; DIAMOND PLATE, .105 ALUMINUM, SINGLE LEFT-HAND SIDE-SWING DOOR; LOCKING T-HANDLE	36	18	18
20-2170DR	ALUMINUM BOX, MILL FINISH .125 BODY; DIAMOND PLATE, .105 ALUMINUM, SINGLE RIGHT-HAND SIDE-SWING DOOR; LOCKING T-HANDLE	36	18	18
20-2170L	ALUMINUM BOX, MILL FINISH .125 BODY; SMOOTH, .112 ALUMINUM SINGLE LEFT-HAND SIDE-SWING DOOR; LOCKING T-HANDLE	36	18	18
20-2170R	ALUMINUM BOX, MILL FINISH .125 BODY; SMOOTH, .112 ALUMINUM SINGLE RIGHT-HAND SIDE-SWING DOOR; LOCKING T-HANDLE	36	18	18
20-2170SS	ALUMINUM BOX, MILL FINISH .125 BODY; STAINLESS STEEL, SINGLE DROP-DOWN DOOR; LOCKING T-HANDLE	36	18	18
20-2175DL	ALUMINUM BOX, MILL FINISH .125 BODY; DIAMOND PLATE, .105 ALUMINUM, DOUBLE SIDE-SWING DOORS; LEFT-DOOR LOCKING T-HANDLE	36	18	18
20-2175DR	ALUMINUM BOX, MILL FINISH .125 BODY; DIAMOND PLATE, .105 ALUMINUM, DOUBLE SIDE-SWING DOORS; RIGHT-DOOR LOCKING T-HANDLE	36	18	18

ALUMINUM STORAGE & TOOLBOXES (Continued)		W"	D"	H"
20-2175L	ALUMINUM BOX, MILL FINISH .125 BODY; SMOOTH, .112 ALUMINUM DOUBLE SIDE-SWING DOORS; LEFT-DOOR LOCKING T-HANDLE	36	18	18
20-2175R	ALUMINUM BOX, MILL FINISH .125 BODY; SMOOTH, .112 ALUMINUM DOUBLE SIDE-SWING DOORS; RIGHT-DOOR LOCKING T-HANDLE	36	18	18
20-2190	ALUMINUM BOX, MILL FINISH .125 BODY; SMOOTH, .112 ALUMINUM SINGLE DROP-DOWN DOOR; LOCKING T-HANDLE	36	24	18
20-2190D	ALUMINUM BOX, MILL FINISH .125 BODY; DIAMOND PLATE, .105 ALUMINUM, SINGLE DROP-DOWN DOOR; LOCKING T-HANDLE	36	24	18
20-2190DL	ALUMINUM BOX, MILL FINISH .125 BODY; DIAMOND PLATE, .105 ALUMINUM, DOUBLE SIDE-SWING DOORS; LEFT-DOOR LOCKING T-HANDLE	36	24	18
20-2190DR	ALUMINUM BOX, MILL FINISH .125 BODY; DIAMOND PLATE, .105 ALUMINUM, DOUBLE SIDE-SWING DOORS; RIGHT-DOOR LOCKING T-HANDLE	36	24	18
20-2190L	ALUMINUM BOX, MILL FINISH .125 BODY; SMOOTH, .112 ALUMINUM SINGLE LEFT-HAND SIDE-SWING DOOR; LOCKING T-HANDLE	36	24	18
20-2190R	ALUMINUM BOX, MILL FINISH .125 BODY; SMOOTH, .112 ALUMINUM SINGLE RIGHT-HAND SIDE-SWING DOOR; LOCKING T-HANDLE	36	24	18
20-2190SS	ALUMINUM BOX, MILL FINISH .125 BODY; STAINLESS STEEL, SINGLE DROP-DOWN DOOR; LOCKING T-HANDLE	36	24	18
20-2195DL	ALUMINUM BOX, MILL FINISH .125 BODY; DIAMOND PLATE, .105 ALUMINUM, .105 ALUMINUM, DOUBLE SIDE-SWING DOORS; LEFT-DOOR LOCKING T-HANDLE	36	24	18
20-2195DR	ALUMINUM BOX, MILL FINISH .125 BODY; DIAMOND PLATE, .105 ALUMINUM, .105 ALUMINUM, DOUBLE SIDE-SWING DOORS; RIGHT-DOOR LOCKING T-HANDLE	36	24	18
20-2195L	ALUMINUM BOX, MILL FINISH .125 BODY; SMOOTH, .112 ALUMINUM DOUBLE SIDE-SWING DOORS; LEFT-DOOR LOCKING T-HANDLE	36	24	18
20-2195R	ALUMINUM BOX, MILL FINISH .125 BODY; SMOOTH, .112 ALUMINUM DOUBLE SIDE-SWING DOORS; RIGHT-DOOR LOCKING T-HANDLE	36	24	18
20-2204	ALUMINUM BOX, MILL FINISH .125 BODY; SMOOTH, .112 ALUMINUM SINGLE DROP-DOWN DOOR; LOCKING T-HANDLE	48	24	24
20-2204D	ALUMINUM BOX, MILL FINISH .125 BODY; DIAMOND PLATE, .105 ALUMINUM, .105 ALUMINUM, SINGLE DROP-DOWN DOOR; LOCKING T-HANDLE	48	24	24
20-2204SS	ALUMINUM BOX, MILL FINISH .125 BODY; STAINLESS STEEL SINGLE DROP-DOWN DOOR; LOCKING T-HANDLE	48	24	24

MEDIUM-DUTY TO CLASS-8

ALUMINUM STORAGE & TOOLBOXES (Continued)		W"	D"	H"
20—2214DL	ALUMINUM BOX, MILL FINISH .125 BODY; DIAMOND PLATE, .105 ALUMINUM, .105 ALUMINUM, DOUBLE SIDE-SWING DOORS; LEFT-DOOR LOCKING T-HANDLE	48	24	24
20—2214DR	ALUMINUM BOX, MILL FINISH .125 BODY; DIAMOND PLATE, .105 ALUMINUM, .105 ALUMINUM, DOUBLE SIDE-SWING DOORS; RIGHT-DOOR LOCKING T-HANDLE	48	24	24
20—2214L	ALUMINUM BOX, MILL FINISH .125 BODY; SMOOTH, .112 ALUMINUM DOUBLE SIDE-SWING DOORS; LEFT-DOOR LOCKING T-HANDLE	48	24	24
20—2214R	ALUMINUM BOX, MILL FINISH .125 BODY; SMOOTH, .112 ALUMINUM DOUBLE SIDE-SWING DOORS; RIGHT-DOOR LOCKING T-HANDLE	48	24	24
20—2270	ALUMINUM BOX, MILL FINISH .125 BODY; SMOOTH, .112 ALUMINUM SINGLE DROP-DOWN DOOR; LOCKING T-HANDLE	48	18	18
20—2270D	ALUMINUM BOX, MILL FINISH .125 BODY; DIAMOND PLATE, .105 ALUMINUM, .105 ALUMINUM, SINGLE DROP-DOWN DOOR; LOCKING T-HANDLE	48	18	18
20—2270SS	ALUMINUM BOX, MILL FINISH .125 BODY; STAINLESS STEEL, SINGLE DROP-DOWN DOOR; LOCKING T-HANDLE	48	18	18
20—2275DL	ALUMINUM BOX, MILL FINISH .125 BODY; DIAMOND PLATE, .105 ALUMINUM, .105 ALUMINUM, DOUBLE SIDE-SWING DOORS; LEFT-DOOR LOCKING T-HANDLE	48	18	18
20—2275DR	ALUMINUM BOX, MILL FINISH .125 BODY; DIAMOND PLATE, .105 ALUMINUM, .105 ALUMINUM, DOUBLE SIDE-SWING DOORS; RIGHT-DOOR LOCKING T-HANDLE	48	18	18
20—2275L	ALUMINUM BOX, MILL FINISH .125 BODY; SMOOTH, .112 ALUMINUM DOUBLE SIDE-SWING DOORS; LEFT-DOOR LOCKING T-HANDLE	48	18	18
20—2275R	ALUMINUM BOX, MILL FINISH .125 BODY; SMOOTH, .112 ALUMINUM DOUBLE SIDE-SWING DOORS; RIGHT-DOOR LOCKING T-HANDLE	48	18	18
20—2290	ALUMINUM BOX, MILL FINISH .125 BODY; SMOOTH, .112 ALUMINUM SINGLE DROP-DOWN DOOR; LOCKING T-HANDLE	48	24	18
20—2290D	ALUMINUM BOX, MILL FINISH .125 BODY; DIAMOND PLATE, .105 ALUMINUM, .105 ALUMINUM, SINGLE DROP-DOWN DOOR; LOCKING T-HANDLE	48	24	18
20—2290SS	ALUMINUM BOX, MILL FINISH .125 BODY; STAINLESS STEEL, SINGLE DROP-DOWN DOOR; LOCKING T-HANDLE	48	24	18
20—2295DL	ALUMINUM BOX, MILL FINISH .125 BODY; DIAMOND PLATE, .105 ALUMINUM, .105 ALUMINUM, DOUBLE SIDE-SWING DOORS; LEFT-DOOR LOCKING T-HANDLE	48	24	18

ALUMINUM STORAGE & TOOLBOXES (Continued)		W"	D"	H"
20—2295DR	ALUMINUM BOX, MILL FINISH .125 BODY; DIAMOND PLATE, .105 ALUMINUM, DOUBLE SIDE-SWING DOORS; RIGHT-DOOR LOCKING T-HANDLE	48	24	18
20—2295L	ALUMINUM BOX, MILL FINISH .125 BODY; SMOOTH, .112 ALUMINUM DOUBLE SIDE-SWING DOORS; LEFT-DOOR LOCKING T-HANDLE	48	24	18
20—2295R	ALUMINUM BOX, MILL FINISH .125 BODY; SMOOTH, .112 ALUMINUM DOUBLE SIDE-SWING DOORS; RIGHT-DOOR LOCKING T-HANDLE	48	24	18
20—2304	ALUMINUM BOX, MILL FINISH .125 BODY; SMOOTH, .112 ALUMINUM SINGLE DROP-DOWN DOOR; LOCKING T-HANDLE	60	24	24
20—2304D	ALUMINUM BOX, MILL FINISH .125 BODY; DIAMOND PLATE, .105 ALUMINUM, SINGLE DROP-DOWN DOOR; LOCKING T-HANDLE	60	24	24
20—2314DL	ALUMINUM BOX, MILL FINISH .125 BODY; DIAMOND PLATE, .105 ALUMINUM, DOUBLE SIDE-SWING DOORS; LEFT-DOOR LOCKING T-HANDLE	60	24	24
20—2314DR	ALUMINUM BOX, MILL FINISH .125 BODY; DIAMOND PLATE, .105 ALUMINUM, DOUBLE SIDE-SWING DOORS; RIGHT-DOOR LOCKING T-HANDLE	60	24	24
20—2314L	ALUMINUM BOX, MILL FINISH .125 BODY; SMOOTH, .112 ALUMINUM DOUBLE SIDE-SWING DOORS; LEFT-DOOR LOCKING T-HANDLE	60	24	24
20—2314R	ALUMINUM BOX, MILL FINISH .125 BODY; SMOOTH, .112 ALUMINUM DOUBLE SIDE-SWING DOORS; RIGHT-DOOR LOCKING T-HANDLE	60	24	24
20—2370	ALUMINUM BOX, MILL FINISH .125 BODY; SMOOTH, .112 ALUMINUM SINGLE DROP-DOWN DOOR; LOCKING T-HANDLE	60	18	18
20—2370D	ALUMINUM BOX, MILL FINISH .125 BODY; DIAMOND PLATE, .105 ALUMINUM, SINGLE DROP-DOWN DOOR; LOCKING T-HANDLE	60	18	18
20—2375DL	ALUMINUM BOX, MILL FINISH .125 BODY; DIAMOND PLATE, .105 ALUMINUM, DOUBLE SIDE-SWING DOORS; LEFT-HAND LOCKING T-HANDLE	60	18	18
20—2375DR	ALUMINUM BOX, MILL FINISH .125 BODY; DIAMOND PLATE, .105 ALUMINUM, DOUBLE SIDE-SWING DOORS; RIGHT-HAND LOCKING T-HANDLE	60	18	18
20—2375L	ALUMINUM BOX, MILL FINISH .125 BODY; SMOOTH, .112 ALUMINUM DOUBLE SIDE-SWING DOORS; LEFT-HAND LOCKING T-HANDLE	60	18	18
20—2375R	ALUMINUM BOX, MILL FINISH .125 BODY; SMOOTH, .112 ALUMINUM DOUBLE SIDE-SWING DOORS; RIGHT-HAND LOCKING T-HANDLE	60	18	18
20—2390	ALUMINUM BOX, MILL FINISH .125 BODY; SMOOTH, .112 ALUMINUM SINGLE DROP-DOWN DOOR; LOCKING T-HANDLE	60	24	18

ALUMINUM STORAGE BOXES

ALUMINUM STORAGE & TOOLBOXES (Continued)		W"	D"	H"
20-2390D	ALUMINUM BOX, MILL FINISH .125 BODY; DIAMOND PLATE, .105 ALUMINUM, SINGLE DROP-DOWN DOOR; LOCKING T-HANDLE	60	24	18
20-2390SS	ALUMINUM BOX, MILL FINISH .125 BODY; STAINLESS STEEL, SINGLE DROP-DOWN DOOR; LOCKING T-HANDLE	60	24	18
20-2395DL	ALUMINUM BOX, MILL FINISH .125 BODY; DIAMOND PLATE, .105 ALUMINUM, DOUBLE SIDE-SWING DOORS; LEFT-HAND LOCKING T-HANDLE	60	24	18
20-2395DR	ALUMINUM BOX, MILL FINISH .125 BODY; DIAMOND PLATE, .105 ALUMINUM, DOUBLE SIDE-SWING DOORS; RIGHT-HAND LOCKING T-HANDLE	60	24	18
20-2395L	ALUMINUM BOX, MILL FINISH .125 BODY; SMOOTH, .112 ALUMINUM DOUBLE SIDE-SWING DOORS; LEFT-HAND LOCKING T-HANDLE	60	24	18
20-2395R	ALUMINUM BOX, MILL FINISH .125 BODY; SMOOTH, .112 ALUMINUM DOUBLE SIDE-SWING DOORS; RIGHT-HAND LOCKING T-HANDLE	60	24	18
20-2604	ALUMINUM BOX, MILL FINISH .125 BODY; SMOOTH, .112 ALUMINUM SINGLE DROP-DOWN DOOR; LOCKING T-HANDLE	72	24	24
20-2604D	ALUMINUM BOX, MILL FINISH .125 BODY; DIAMOND PLATE, .105 ALUMINUM, SINGLE DROP-DOWN DOOR; LOCKING T-HANDLE	72	24	24
20-2604SS	ALUMINUM BOX, MILL FINISH .125 BODY; STAINLESS STEEL, SINGLE DROP-DOWN DOOR; LOCKING T-HANDLE	72	24	24
20-2614DL	ALUMINUM BOX, MILL FINISH .125 BODY; LARGE LOWER BODY LIP; RIBBED BOTTOM SURFACE FOR RIGIDITY; DIAMOND PLATE, .105 ALUMINUM, DOUBLE SIDE-SWING DOORS; LEFT-HAND LOCKING T-HANDLE	72	24	24
20-2614DR	ALUMINUM BOX, MILL FINISH .125 BODY; LARGE LOWER BODY LIP; RIBBED BOTTOM SURFACE FOR RIGIDITY; DIAMOND PLATE, .105 ALUMINUM, DOUBLE SIDE-SWING DOORS; RIGHT-HAND LOCKING T-HANDLE	72	24	24
20-2614L	ALUMINUM BOX, MILL FINISH .125 BODY; LARGE LOWER BODY LIP; RIBBED BOTTOM SURFACE FOR RIGIDITY; DIAMOND PLATE, .105 ALUMINUM, DOUBLE SIDE-SWING DOORS; LEFT-HAND LOCKING T-HANDLE	72	24	24
20-2614R	ALUMINUM BOX, MILL FINISH .125 BODY; LARGE LOWER BODY LIP; RIBBED BOTTOM SURFACE FOR RIGIDITY; DIAMOND PLATE, .105 ALUMINUM, DOUBLE SIDE-SWING DOORS; RIGHT-HAND LOCKING T-HANDLE	72	24	24
20-2690	ALUMINUM BOX, MILL FINISH .125 BODY; SMOOTH, .112 ALUMINUM SINGLE DROP-DOWN DOOR; LOCKING T-HANDLE	72	24	18

ALUMINUM STORAGE & TOOLBOXES (Continued)		W"	D"	H"
20-2690D	ALUMINUM BOX, MILL FINISH .125 BODY; DIAMOND PLATE, .105 ALUMINUM, SINGLE DROP-DOWN DOOR; LOCKING T-HANDLE	72	24	18
20-2690SS	ALUMINUM BOX, MILL FINISH .125 BODY; STAINLESS STEEL, SINGLE DROP-DOWN DOOR; LOCKING T-HANDLE	72	24	18
20-2695DL	ALUMINUM BOX, MILL FINISH .125 BODY; DIAMOND PLATE, .105 ALUMINUM, DOUBLE SIDE-SWING DOORS; LEFT-DOOR LOCKING T-HANDLE	72	24	18
20-2695DR	ALUMINUM BOX, MILL FINISH .125 BODY; DIAMOND PLATE, .105 ALUMINUM, DOUBLE SIDE-SWING DOORS; RIGHT-DOOR LOCKING T-HANDLE	72	24	18
20-2695L	ALUMINUM BOX, MILL FINISH .125 BODY; SMOOTH, .112 ALUMINUM DOUBLE SIDE-SWING DOORS; LEFT-DOOR LOCKING T-HANDLE	72	24	18
20-2695R	ALUMINUM BOX, MILL FINISH .125 BODY; SMOOTH, .112 ALUMINUM DOUBLE SIDE-SWING DOORS; RIGHT-DOOR LOCKING T-HANDLE	72	24	18
20-2680T	ALUMINUM BOX, MILL FINISH .125 BODY; CROSS FRAME MOUNT; DIAMOND PLATE, TOP-OPEN LID; STAINLESS STEEL T-HANDLE LOCK	30	10	12
ALUMINUM TOOLBOX — SLOPE TOP		W"	D"	H"
20-2401	ALUMINUM BOX, POLISHED BODY; CLASS-8 CAB RACK MOUNTABLE, SLOPE-TOP, DIAMOND PLATE UP-SWING DOOR; LOCKING T-HANDLE	24	25	19
20-2401S	ALUMINUM BOX, POLISHED BODY; CLASS-8 CAB RACK MOUNTABLE, SLOPE-TOP, SMOOTH UP-SWING DOOR; LOCKING T-HANDLE	24	25	19
20-2408	ALUMINUM BOX, POLISHED BODY; FRAME TOP MOUNT, SLOPE-TOP, SMOOTH TOP-OPEN LID; STAINLESS STEEL T-HANDLE LOCK	30	18	18
20-2410	ALUMINUM BOX, POLISHED BODY; FRAME TOP MOUNT, SLOPE-TOP, DIAMOND PLATE TOP-OPEN LID; STAINLESS STEEL T-HANDLE LOCK	30	20	20
20-2410-24	ALUMINUM BOX, POLISHED BODY; FRAME TOP MOUNT, SLOPE-TOP, DIAMOND PLATE TOP-OPEN LID; STAINLESS STEEL T-HANDLE LOCK	24	20	20
20-2410-33	ALUMINUM BOX, POLISHED BODY; FRAME TOP MOUNT, SLOPE-TOP, DIAMOND PLATE TOP-OPEN LID; STAINLESS STEEL T-HANDLE LOCK	33	20	20
20-2410S	ALUMINUM BOX, POLISHED BODY; FRAME TOP MOUNT, SLOPE-TOP, SMOOTH TOP-OPEN LID; STAINLESS STEEL T-HANDLE LOCK	30	20	20
20-2412	ALUMINUM BOX, POLISHED BODY; FRAME TOP MOUNT, SLOPE-TOP, DIAMOND PLATE TOP-OPEN LID; STAINLESS STEEL T-HANDLE LOCK	24	24	24

MEDIUM-DUTY TO CLASS-8

ALUMINUM STEP BOXES — FRAME MOUNT		W"	D"	H"
20—2450	ALUMINUM STEP BOX; .105 DIAMOND PLATE ALUMINUM LID; GRIP STRUT* STEP; BULB SEALS; STAINLESS STEEL KEYED T-LOCK; INTERNAL BRACKETS	12	28	25
20—2450S	ALUMINUM STEP BOX; .112 POLISHED ALUMINUM LID; GRIP STRUT* STEP; BULB SEALS; STAINLESS STEEL KEYED T-LOCK; INTERNAL BRACKETS	12	28	25
20—2460	ALUMINUM STEP BOX; .105 DIAMOND PLATE ALUMINUM LID; GRIP STRUT* STEP; BULB SEALS; STAINLESS STEEL KEYED T-LOCK; INTERNAL BRACKETS	18	28	25
20—2460S	ALUMINUM STEP BOX; .112 POLISHED ALUMINUM LID; GRIP STRUT* STEP; BULB SEALS; STAINLESS STEEL KEYED T-LOCK; INTERNAL BRACKETS	18	28	25
20—2470	ALUMINUM STEP BOX; .105 DIAMOND PLATE ALUMINUM LID; GRIP STRUT* STEP; BULB SEALS; STAINLESS STEEL KEYED T-LOCK; INTERNAL BRACKETS	24	28	25
20—2470S	ALUMINUM STEP BOX; .112 POLISHED ALUMINUM LID; GRIP STRUT* STEP; BULB SEALS; STAINLESS STEEL KEYED T-LOCK; INTERNAL BRACKETS	24	28	25
20—2480	ALUMINUM STEP BOX; .105 DIAMOND PLATE ALUMINUM LID; GRIP STRUT* STEP; BULB SEALS; STAINLESS STEEL KEYED T-LOCK; EXTERNAL BRACKETS NOT INCLUDED	30	28	25
20—2480S	ALUMINUM STEP BOX; .112 POLISHED ALUMINUM LID; GRIP STRUT* STEP; BULB SEALS; STAINLESS STEEL KEYED T-LOCK; EXTERNAL BRACKETS NOT INCLUDED	30	28	25
20—2490	ALUMINUM STEP BOX; .105 DIAMOND PLATE ALUMINUM LID; GRIP STRUT* STEP; BULB SEALS; STAINLESS STEEL KEYED T-LOCK; EXTERNAL BRACKETS NOT INCLUDED	36	28	25
20—2490S	ALUMINUM STEP BOX; .112 POLISHED ALUMINUM LID; GRIP STRUT* STEP; BULB SEALS; STAINLESS STEEL KEYED T-LOCK; EXTERNAL BRACKETS NOT INCLUDED	36	28	25
ALUMINUM TOP-STEP BOXES — FRAME MOUNT		W"	D"	H"
20—2453	ALUMINUM STEP BOX, TOP-STEP-ONLY; .105 DIAMOND PLATE ALUMINUM LID; GRIP STRUT* STEP; BULB SEALS; STAINLESS STEEL KEYED T-LOCK; INTERNAL BRACKETS	12	20	25
20—2453S	ALUMINUM STEP BOX, TOP-STEP-ONLY; .112 POLISHED ALUMINUM LID; GRIP STRUT* STEP; BULB SEALS; STAINLESS STEEL KEYED T-LOCK; INTERNAL BRACKETS	12	20	25
20—2463	ALUMINUM STEP BOX, TOP-STEP-ONLY; .105 DIAMOND PLATE ALUMINUM LID; GRIP STRUT* STEP; BULB SEALS; STAINLESS STEEL KEYED T-LOCK; INTERNAL BRACKETS	18	20	25
20—2463S	ALUMINUM STEP BOX, TOP-STEP-ONLY; .112 POLISHED ALUMINUM LID; GRIP STRUT* STEP; BULB SEALS; STAINLESS STEEL KEYED T-LOCK; INTERNAL BRACKETS	18	20	25

ALUMINUM TOP-STEP BOXES — FRAME MOUNT (Continued)		W"	D"	H"
20—2473	ALUMINUM STEP BOX, TOP-STEP-ONLY; .105 DIAMOND PLATE ALUMINUM LID; GRIP STRUT* STEP; BULB SEALS; STAINLESS STEEL KEYED T-LOCK; INTERNAL BRACKETS	24	20	25
20—2473S	ALUMINUM STEP BOX, TOP-STEP-ONLY; .112 POLISHED ALUMINUM LID; GRIP STRUT* STEP; BULB SEALS; STAINLESS STEEL KEYED T-LOCK; INTERNAL BRACKETS	24	20	25
20—2483	ALUMINUM STEP BOX, TOP-STEP-ONLY; .105 DIAMOND PLATE ALUMINUM LID; GRIP STRUT* STEP; BULB SEALS; STAINLESS STEEL KEYED T-LOCK; INTERNAL BRACKETS	30	20	25
20—2483S	ALUMINUM STEP BOX, TOP-STEP-ONLY; .112 POLISHED ALUMINUM LID; GRIP STRUT* STEP; BULB SEALS; STAINLESS STEEL KEYED T-LOCK; INTERNAL BRACKETS	30	20	25
20—2493	ALUMINUM STEP BOX, TOP-STEP-ONLY; .105 DIAMOND PLATE ALUMINUM LID; GRIP STRUT* STEP; BULB SEALS; STAINLESS STEEL KEYED T-LOCK; BRACKETS NOT INCLUDED	36	20	25
20—2493S	ALUMINUM STEP BOX, TOP-STEP-ONLY; .112 POLISHED ALUMINUM LID; GRIP STRUT* STEP; BULB SEALS; STAINLESS STEEL KEYED T-LOCK; BRACKETS NOT INCLUDED	36	20	25
ALUMINUM STEPLESS TOOLBOXES FRAME-MOUNT		W"	D"	H"
20—2455	ALUMINUM TOOLBOX, STEPLESS; SLOPED, .105 DIAMOND PLATE ALUMINUM LID; BULB SEALS; STAINLESS STEEL KEYED T-LOCK; INTERNAL BRACKETS	12	20	22
20—2455S	ALUMINUM TOOLBOX, STEPLESS; SLOPED, .112 POLISHED ALUMINUM LID; BULB SEALS; STAINLESS STEEL KEYED T-LOCK; INTERNAL BRACKETS	12	20	22
20—2465	ALUMINUM TOOLBOX, STEPLESS; SLOPED, .105 DIAMOND PLATE ALUMINUM LID; BULB SEALS; STAINLESS STEEL KEYED T-LOCK; INTERNAL BRACKETS	18	20	22
20—2465S	ALUMINUM TOOLBOX, STEPLESS; SLOPED, .112 POLISHED ALUMINUM LID; BULB SEALS; STAINLESS STEEL KEYED T-LOCK; INTERNAL BRACKETS	18	20	22
20—2475	ALUMINUM TOOLBOX, STEPLESS; SLOPED, .105 DIAMOND PLATE ALUMINUM LID; BULB SEALS; STAINLESS STEEL KEYED T-LOCK; INTERNAL BRACKETS	22	20	22
20—2475S	ALUMINUM TOOLBOX, STEPLESS; SLOPED, .112 POLISHED ALUMINUM LID; BULB SEALS; STAINLESS STEEL KEYED T-LOCK; INTERNAL BRACKETS	22	20	22
20—2485	ALUMINUM TOOLBOX, STEPLESS; SLOPED, .105 DIAMOND PLATE ALUMINUM LID; BULB SEALS; STAINLESS STEEL KEYED T-LOCK; BRACKETS NOT INCLUDED	30	20	22

ALUMINUM STORAGE BOXES

ALUMINUM STEPLESS TOOLBOXES FRAME-MOUNT (Continued)		W"	D"	H"
20-2485S	ALUMINUM TOOLBOX, STEPLESS; SLOPED, .112 POLISHED ALUMINUM LID; BULB SEALS; STAINLESS STEEL KEYED T-LOCK; BRACKETS NOT INCLUDED	30	20	22
20-2495	ALUMINUM TOOLBOX, STEPLESS; SLOPED, .105 DIAMOND PLATE ALUMINUM LID; BULB SEALS; STAINLESS STEEL KEYED T-LOCK; BRACKETS NOT INCLUDED	36	20	22
20-2495S	ALUMINUM TOOLBOX, STEPLESS; SLOPED, .112 POLISHED ALUMINUM LID; BULB SEALS; STAINLESS STEEL KEYED T-LOCK; BRACKETS NOT INCLUDED	36	20	22
ALUMINUM CAB-ENTRY STEP BOXES		W"	D"	H"
20-2909-24	ALUMINUM CAB ENTRY BOX; GRIP STRUT® STEP; FULL HINGE, UP-SWING LID, BULB SEALS; STAINLESS STEEL KEYED T-LOCK; PETERBILT	24	30	15
20-2909-31	ALUMINUM CAB ENTRY BOX; GRIP STRUT® STEP; FULL HINGE, UP-SWING LID, BULB SEALS; STAINLESS STEEL KEYED T-LOCK; PETERBILT	31	30	15
20-2944	ALUMINUM CAB ENTRY BOX; GRIP STRUT® STEP; FULL HINGE, UP-SWING LID, BULB SEALS; STAINLESS STEEL KEYED T-LOCK; FREIGHTLINER	36	25	18
20-2911-24	ALUMINUM CAB ENTRY BOX; GRIP STRUT® STEP; FULL HINGE, UP-SWING LID, BULB SEALS; STAINLESS STEEL KEYED T-LOCK; BRACKETS NOT INCLUDED	24	30	15
20-2911-31	ALUMINUM CAB ENTRY BOX; GRIP STRUT® STEP; FULL HINGE, UP-SWING LID, BULB SEALS; STAINLESS STEEL KEYED T-LOCK; BRACKETS NOT INCLUDED	31	30	15
20-9751	ANGLE MOUNT BRACKETS (PAIR) FOR CAB-ENTRY STEP BOX			
ALUMINUM BATTERY BOXES		W"	D"	H"
20-2953	ALUMINUM BATTERY BOX, STEPLESS; DIAMOND PLATE COVER; CLAMP-STYLE COVER LATCH; BRACKETS NOT INCLUDED	30	22	15
20-2955	ALUMINUM BATTERY BOX; GRIP STRUT® BOTTOM STEP WITH 7" RISE; DIAMOND PLATE COVER; CLAMP-STYLE COVER LATCH; BRACKETS NOT INCLUDED	30	22	15
20-2957	ALUMINUM BATTERY BOX; SINGLE GRIP STRUT® TOP STEP; DIAMOND PLATE COVER; CLAMP-STYLE COVER LATCH; BRACKETS NOT INCLUDED	30	22	15
20-2959	ALUMINUM BATTERY BOX; GRIP STRUT® STEPS, TOP AND BOTTOM; DIAMOND PLATE COVER; CLAMP-STYLE COVER LATCH; BRACKETS NOT INCLUDED	30	30	15
20-9753	ANGLE MOUNTING KIT FOR BATTERY BOXES			
20-9953	J-CLAMP MOUNTING KIT FOR BATTERY BOX			

ALUMINUM IN-FRAME TOOLBOXES		W"	D"	H"
20-2647	ALUMINUM IN-FRAME TOOLBOX; DIAMOND PLATE COVER; BULB SEALS; HINGE HASP; INCLUDES MOUNTING KIT	30	22	8
20-2649	ALUMINUM IN-FRAME TOOLBOX; DIAMOND PLATE COVER; BULB SEALS; HINGE HASP; INCLUDES MOUNTING KIT	30	22	10
ALUMINUM TOOLBOX MOUNTING BRACKETS		W"	D"	H"
20-9700	MOUNTING BRACKETS (PAIR) FOR A 24"D TOOLBOX			
20-9710	MOUNTING BRACKETS (PAIR) FOR AN 18"D TOOLBOX			
20-9720	MOUNTING BRACKETS (PAIR) FOR A 30"D TOOLBOX			
20-9741	MOUNTING BRACKETS FOR ALUMINUM BOX 20-2401			
20-9953	BATTERY BOX FLAT- BAR CLAMP KIT WITH J-HOOKS			
ALUMINUM TOOLBOX CONFIGURED OPTIONS				
SHELF WITH INSTALLATION		W"	D"	H"
20-2500-24	SHELF FOR ALUMINUM BOX TO 24 INCHES WIDE; WELD-IN INSTALLATION			
20-2500-36	SHELF FOR ALUMINUM BOX 25 TO 36 INCHES WIDE; WELD-IN INSTALLATION			
20-2500-48	SHELF FOR ALUMINUM BOX 37 TO 48 INCHES WIDE; WELD-IN INSTALLATION			
20-2500-60	SHELF FOR ALUMINUM BOX 49 TO 60 INCHES WIDE; WELD-IN INSTALLATION			
DRAWER MODULES		W"	D"	H"
20-2524	ALUMINUM DRAWER MODULE; 3 DRAWER FITS IN 24"Wx18"Dx18H TOOL BOX (SHIPS LOOSE)	16	14	12
20-2530	ALUMINUM DRAWER MODULE; 3 DRAWER FITS IN 30"Wx18"Dx18H TOOL BOX (SHIPS LOOSE)	22.5	14	12

MEDIUM-DUTY TO CLASS-8



↑ SINGLE DROP-DOWN DOOR

SHOWN: 22-2012-WH Mild steel box with white powder coat; single, drop-down door and stainless steel T-handle lock. 18"W x15"Dx15"H. Available in black (BK) and a side swing door (22-2012S).



↑ SINGLE DROP-DOWN DOOR

SHOWN: 22-2018B-BK Mild steel box with black powder coat; single, drop-down door and stainless steel T-handle lock. 18"Wx18"Dx18"H. Available in white (WH) or with a hinge hasp (H)



↑ SINGLE DROP-DOWN DOOR

SHOWN: 22-2028B-BK Mild steel box with black powder coat; single, drop-down door and stainless steel T-handle lock. 24"W x18"Dx18"H. Available in white (WH) or with a hinge hasp (H).



↑ SINGLE DROP-DOWN DOOR

SHOWN: 22-2332B-BK Mild steel box with black powder coat; single, drop-down door and dual stainless steel T-handle locks. 60"Wx18"Dx18"H. Available in white (WH) or with a hinge hasp (H).



↑ SLOPE-TOP / TOP-OPEN

SHOWN: 22-2431-WH Mild steel box with white powder coat; slope-top; top-open lid; hinge hasp. 24"Wx-18"Dx18"H. Available in black (BK).



↑ FLAT-TOP / TOP-OPEN

SHOWN: 22-2432-BK Mild steel box with black powder coat; flat-top; top-open lid; hinge hasp. 24"Wx18"Dx18"H. Available in white (WH).

OVER A HUNDRED STANDARD STEEL STORAGE BOXES

Standard steel toolboxes are made from 14 GA mild steel and then powder coated in either black or white. Custom colors are available for special orders.

Double-swing doors are available on any 36" or longer box. On double-swing door boxes, it is necessary to specify drivers side (L) or passenger (R) placement, since the locking T-handle is placed on the cab-side door. Simply add the letter (L) or (R) to the part number. Stainless steel (S) doors are also available.

STEEL TOOLBOX OPTIONS

MOUNTING KITS

Kits are black powder coated steel and installed with the longer leg placed vertically.

20-9710: BRACKETS FOR 18" DEEP BOX

20-9700: BRACKETS FOR 24" DEEP BOX

20-9720: BRACKETS FOR 30" DEEP BOX

SHELVES

Shelf installation is available at time of order.

Shelves are welded in place.

22-2500-24 Boxes up to 24-inches wide

22-2500-36 Boxes up to 36-inches wide

22-2500-48 Boxes up to 48-inches wide

22-2500-60 Boxes between 49 to 60-inches wide

22-2500-72 Boxes between 61 to 72-inches wide

FULL LENGTH STAINLESS STEEL PIANO HINGE

On doors and lids for rigidity and water-resistance

NEOPRENE, AUTOMOTIVE BULB SEALS

On compartment openings



STANDARD STEEL STORAGE BOXES

STEEL TOOLBOXES		W"	D"	H"
22-2012-BK	MILD STEEL BOX; BLACK POWDER COAT; SINGLE, DROP-DOWN DOOR; STAINLESS STEEL T-HANDLE LOCK	18	15	15
22-2012-WH	MILD STEEL BOX; WHITE POWDER COAT; SINGLE, DROP-DOWN DOOR; STAINLESS STEEL T-HANDLE LOCK	18	15	15
22-2012S-BK	MILD STEEL BOX; BLACK POWDER COAT; SINGLE, SIDE-SWING DOOR; STAINLESS STEEL T-HANDLE LOCK	18	15	15
22-2014-BK	MILD STEEL BOX; BLACK POWDER COAT; SINGLE, DROP-DOWN DOOR; STAINLESS STEEL T-HANDLE LOCK	24	15	15
22-2014-WH	MILD STEEL BOX; WHITE POWDER COAT; SINGLE, DROP-DOWN DOOR; STAINLESS STEEL T-HANDLE LOCK	24	15	15
22-2014S-BK	MILD STEEL BOX; BLACK POWDER COAT; SINGLE, SIDE-SWING DOOR; STAINLESS STEEL T-HANDLE LOCK	24	15	15
22-2016-BK	MILD STEEL BOX; BLACK POWDER COAT; SINGLE, DROP-DOWN DOOR; STAINLESS STEEL T-HANDLE LOCK	30	15	15
22-2016-WH	MILD STEEL BOX; WHITE POWDER COAT; SINGLE, DROP-DOWN DOOR; STAINLESS STEEL T-HANDLE LOCK	30	15	15
22-2016S-BK	MILD STEEL BOX; BLACK POWDER COAT; SINGLE, SIDE-SWING DOOR; STAINLESS STEEL T-HANDLE LOCK	30	15	15
22-2018B-BK	MILD STEEL BOX; BLACK POWDER COAT; SINGLE, DROP-DOWN DOOR; STAINLESS STEEL T-HANDLE LOCK	18	18	18
22-2018B-WH	MILD STEEL BOX; WHITE POWDER COAT; SINGLE, DROP-DOWN DOOR; STAINLESS STEEL T-HANDLE LOCK	18	18	18
22-2018H-BK	MILD STEEL BOX; BLACK POWDER COAT; SINGLE, DROP-DOWN DOOR; HINGE HASP	18	18	18
22-2018H-WH	MILD STEEL BOX; WHITE POWDER COAT; SINGLE, DROP-DOWN DOOR; HINGE HASP	18	18	18
22-2022H-BK	MILD STEEL BOX; BLACK POWDER COAT; SINGLE, DROP-DOWN DOOR; HINGE HASP	24	24	24
22-2022H-WH	MILD STEEL BOX; WHITE POWDER COAT; SINGLE, DROP-DOWN DOOR; HINGE HASP	24	24	24
22-2028B-BK	MILD STEEL BOX; BLACK POWDER COAT; SINGLE, DROP-DOWN DOOR; STAINLESS STEEL T-HANDLE LOCK	24	18	18
22-2028B-WH	MILD STEEL BOX; WHITE POWDER COAT; SINGLE, DROP-DOWN DOOR; STAINLESS STEEL T-HANDLE LOCK	24	18	18

STEEL TOOLBOXES (Continued)		W"	D"	H"
22-2028H-BK	MILD STEEL BOX; BLACK POWDER COAT; SINGLE, DROP-DOWN DOOR; HINGE HASP	24	18	18
22-2029B-BK	MILD STEEL BOX; BLACK POWDER COAT; SINGLE, DROP-DOWN DOOR; STAINLESS STEEL T-HANDLE LOCK	30	18	18
22-2029B-WH	MILD STEEL BOX; WHITE POWDER COAT; SINGLE, DROP-DOWN DOOR; STAINLESS STEEL T-HANDLE LOCK	30	18	18
22-2029H-BK	MILD STEEL BOX; BLACK POWDER COAT; SINGLE, DROP-DOWN DOOR; HINGE HASP	30	18	18
22-2029H-WH	MILD STEEL BOX; WHITE POWDER COAT; SINGLE, DROP-DOWN DOOR; HINGE HASP	30	18	18
22-2032B-BK	MILD STEEL BOX; BLACK POWDER COAT; SINGLE, DROP-DOWN DOOR; STAINLESS STEEL T-HANDLE LOCK	24	24	24
22-2032B-WH	MILD STEEL BOX; WHITE POWDER COAT; SINGLE, DROP-DOWN DOOR; STAINLESS STEEL T-HANDLE LOCK	24	24	24
22-2033B-BK	MILD STEEL BOX; BLACK POWDER COAT; SINGLE, DROP-DOWN DOOR; STAINLESS STEEL T-HANDLE LOCK	30	24	24
22-2033B-WH	MILD STEEL BOX; WHITE POWDER COAT; SINGLE, DROP-DOWN DOOR; STAINLESS STEEL T-HANDLE LOCK	30	24	24
22-2050B-BK	MILD STEEL BOX; BLACK POWDER COAT; SINGLE, DROP-DOWN DOOR; STAINLESS STEEL T-HANDLE LOCK	24	24	18
22-2050B-WH	MILD STEEL BOX; WHITE POWDER COAT; SINGLE, DROP-DOWN DOOR; STAINLESS STEEL T-HANDLE LOCK	24	24	18
22-2051H-BK	MILD STEEL BOX; BLACK POWDER COAT; SINGLE, DROP-DOWN DOOR; HINGE HASP	24	24	18
22-2051H-WH	MILD STEEL BOX; WHITE POWDER COAT; SINGLE, DROP-DOWN DOOR; HINGE HASP	24	24	18
22-2053B-BK	MILD STEEL BOX; BLACK POWDER COAT; SINGLE, DROP-DOWN DOOR; STAINLESS STEEL T-HANDLE LOCK	30	24	18
22-2053B-WH	MILD STEEL BOX; WHITE POWDER COAT; SINGLE, DROP-DOWN DOOR; STAINLESS STEEL T-HANDLE LOCK	30	24	18
22-2122H-BK	MILD STEEL BOX; BLACK POWDER COAT; SINGLE, DROP-DOWN DOOR; HINGE HASP	36	24	24
22-2122H-WH	MILD STEEL BOX; WHITE POWDER COAT; SINGLE, DROP-DOWN DOOR; HINGE HASP	26	24	24

MEDIUM-DUTY TO CLASS-8

STEEL TOOLBOXES (Continued)		W"	D"	H"
22-2128B-BK	MILD STEEL BOX; BLACK POWDER COAT; SINGLE, DROP-DOWN DOOR; STAINLESS STEEL T-HANDLE LOCK	36	18	18
22-2128B-WH	MILD STEEL BOX; WHITE POWDER COAT; SINGLE, DROP-DOWN DOOR; STAINLESS STEEL T-HANDLE LOCK	36	18	18
22-2128H-BK	MILD STEEL BOX; BLACK POWDER COAT; SINGLE, DROP-DOWN DOOR; HINGE HASP	36	18	18
22-2128H-WH	MILD STEEL BOX; WHITE POWDER COAT; SINGLE, DROP-DOWN DOOR; HINGE HASP	36	18	18
22-2128SS-BK	MILD STEEL BOX; BLACK POWDER COAT, SINGLE DROP-DOWN POLISHED STAINLESS DOOR; STAINLESS STEEL T-HANDLE LOCK	36	18	18
22-2128SS-WH	MILD STEEL BOX; WHITE POWDER COAT, SINGLE DROP-DOWN POLISHED STAINLESS DOOR; STAINLESS STEEL T-HANDLE LOCK	36	18	18
22-2132B-BK	MILD STEEL BOX; BLACK POWDER COAT; SINGLE, DROP-DOWN DOOR; STAINLESS STEEL T-HANDLE LOCK	36	24	24
22-2132B-WH	MILD STEEL BOX; WHITE POWDER COAT; SINGLE, DROP-DOWN DOOR; STAINLESS STEEL T-HANDLE LOCK	36	24	24
22-2135L-BK	MILD STEEL BOX; BLACK POWDER COAT; DOUBLE SIDE-SWING DOORS; LEFT-DOOR STAINLESS STEEL T-HANDLE LOCK	36	24	24
22-2135L-WH	MILD STEEL BOX; WHITE POWDER COAT; DOUBLE SIDE-SWING DOORS; LEFT-DOOR STAINLESS STEEL T-HANDLE LOCK	36	24	24
22-2135R-BK	MILD STEEL BOX; BLACK POWDER COAT; DOUBLE SIDE-SWING DOORS; RIGHT-DOOR STAINLESS STEEL T-HANDLE LOCK	36	24	24
22-2135R-WH	MILD STEEL BOX; WHITE POWDER COAT; DOUBLE SIDE-SWING DOORS; RIGHT-DOOR STAINLESS STEEL T-HANDLE LOCK	36	24	24
22-2138L-BK	MILD STEEL BOX; BLACK POWDER COAT; DOUBLE SIDE-SWING DOORS; LEFT-DOOR STAINLESS STEEL T-HANDLE LOCK	36	18	18
22-2138L-WH	MILD STEEL BOX; WHITE POWDER COAT; DOUBLE SIDE-SWING DOORS; LEFT-DOOR STAINLESS STEEL T-HANDLE LOCK	36	18	18
22-2138R-BK	MILD STEEL BOX; BLACK POWDER COAT; DOUBLE SIDE-SWING DOORS; RIGHT-DOOR STAINLESS STEEL T-HANDLE LOCK	36	18	18

STEEL TOOLBOXES (Continued)		W"	D"	H"
22-2138R-WH	MILD STEEL BOX; WHITE POWDER COAT; DOUBLE SIDE-SWING DOORS; RIGHT-DOOR STAINLESS STEEL T-HANDLE LOCK	36	18	18
22-2150B-BK	MILD STEEL BOX; BLACK POWDER COAT; SINGLE, DROP-DOWN DOOR; STAINLESS STEEL T-HANDLE LOCK	36	24	18
22-2150B-WH	MILD STEEL BOX; WHITE POWDER COAT; SINGLE, DROP-DOWN DOOR; STAINLESS STEEL T-HANDLE LOCK	36	24	18
22-2151H-BK	MILD STEEL BOX; BLACK POWDER COAT; SINGLE, DROP-DOWN DOOR; HINGE HASP	36	24	18
22-2151H-WH	MILD STEEL BOX; WHITE POWDER COAT; SINGLE, DROP-DOWN DOOR; HINGE HASP	36	24	18
22-2155L-BK	MILD STEEL BOX; BLACK POWDER COAT; DOUBLE SIDE-SWING DOORS; LEFT-DOOR STAINLESS STEEL T-HANDLE LOCK	36	24	18
22-2155L-WH	MILD STEEL BOX; WHITE POWDER COAT; DOUBLE SIDE-SWING DOORS; LEFT-DOOR STAINLESS STEEL T-HANDLE LOCK	36	24	18
22-2155R-BK	MILD STEEL BOX; BLACK POWDER COAT; DOUBLE SIDE-SWING DOORS; RIGHT-DOOR STAINLESS STEEL T-HANDLE LOCK	36	24	18
22-2155R-WH	MILD STEEL BOX; WHITE POWDER COAT; DOUBLE SIDE-SWING DOORS; RIGHT-DOOR STAINLESS STEEL T-HANDLE LOCK	36	24	18
22-2222H-BK	MILD STEEL BOX; BLACK POWDER COAT; SINGLE, DROP-DOWN DOOR; HINGE HASP	48	24	24
22-2222H-WH	MILD STEEL BOX; WHITE POWDER COAT; SINGLE, DROP-DOWN DOOR; HINGE HASP	36	24	18
22-2228B-BK	MILD STEEL BOX; BLACK POWDER COAT; SINGLE, DROP-DOWN DOOR; STAINLESS STEEL T-HANDLE LOCK	48	18	18
22-2228B-WH	MILD STEEL BOX; WHITE POWDER COAT; SINGLE, DROP-DOWN DOOR; STAINLESS STEEL T-HANDLE LOCK	48	18	18
22-2228H-BK	MILD STEEL BOX; BLACK POWDER COAT; SINGLE, DROP-DOWN DOOR; HINGE HASP	48	18	18
22-2228H-WH	MILD STEEL BOX; WHITE POWDER COAT; SINGLE, DROP-DOWN DOOR; HINGE HASP	48	18	18
22-2228SS-BK	MILD STEEL BOX; BLACK POWDER COAT; SINGLE DROP-DOWN STAINLESS DOOR; STAINLESS STEEL T-HANDLE LOCK	48	18	18

STANDARD STEEL STORAGE BOXES

STEEL TOOLBOXES (Continued)		W"	D"	H"
22-2228SS-WH	MILD STEEL BOX; WHITE POWDER COAT, SINGLE DROP-DOWN STAINLESS DOOR; STAINLESS STEEL T-HANDLE LOCK	48	18	18
22-2232B-BK	MILD STEEL BOX; BLACK POWDER COAT; SINGLE, DROP-DOWN DOOR; STAINLESS STEEL T-HANDLE LOCK	48	24	24
22-2232B-WH	MILD STEEL BOX; WHITE POWDER COAT; SINGLE, DROP-DOWN DOOR; STAINLESS STEEL T-HANDLE LOCK	48	24	24
22-2232SS-BK	MILD STEEL BOX; BLACK POWDER COAT, SINGLE DROP-DOWN STAINLESS DOOR; STAINLESS STEEL T-HANDLE LOCK	48	24	24
22-2232SS-WH	MILD STEEL BOX; WHITE POWDER COAT, SINGLE DROP-DOWN STAINLESS DOOR; STAINLESS STEEL T-HANDLE LOCK	48	24	24
22-2235L-BK	MILD STEEL BOX; BLACK POWDER COAT; DOUBLE SIDE-SWING DOORS; LEFT-DOOR STAINLESS STEEL T-HANDLE LOCK	48	24	24
22-2235L-WH	MILD STEEL BOX; WHITE POWDER COAT; DOUBLE SIDE-SWING DOORS; LEFT-DOOR STAINLESS STEEL T-HANDLE LOCK	48	24	24
22-2235R-BK	MILD STEEL BOX; BLACK POWDER COAT; DOUBLE SIDE-SWING DOORS; RIGHT-DOOR STAINLESS STEEL T-HANDLE LOCK	48	24	24
22-2235R-WH	MILD STEEL BOX; WHITE POWDER COAT; DOUBLE SIDE-SWING DOORS; RIGHT-DOOR STAINLESS STEEL T-HANDLE LOCK	48	24	24
22-2238L-BK	MILD STEEL BOX; BLACK POWDER COAT; DOUBLE SIDE-SWING DOORS; LEFT-DOOR STAINLESS STEEL T-HANDLE LOCK	48	18	18
22-2238L-WH	MILD STEEL BOX; WHITE POWDER COAT; DOUBLE SIDE-SWING DOORS; LEFT-DOOR STAINLESS STEEL T-HANDLE LOCK	48	18	18
22-2238R-BK	MILD STEEL BOX; BLACK POWDER COAT; DOUBLE SIDE-SWING DOORS; RIGHT-DOOR STAINLESS STEEL T-HANDLE LOCK	48	18	18
22-2238R-WH	MILD STEEL BOX; WHITE POWDER COAT; DOUBLE SIDE-SWING DOORS; RIGHT-DOOR STAINLESS STEEL T-HANDLE LOCK	48	18	18
22-2250B-BK	MILD STEEL BOX; BLACK POWDER COAT; SINGLE, DROP-DOWN DOOR; STAINLESS STEEL T-HANDLE LOCK	48	24	18
22-2250B-WH	MILD STEEL BOX; WHITE POWDER COAT; SINGLE, DROP-DOWN DOOR; STAINLESS STEEL T-HANDLE LOCK	48	24	18

STEEL TOOLBOXES (Continued)		W"	D"	H"
22-2251H-BK	MILD STEEL BOX; BLACK POWDER COAT; SINGLE, DROP-DOWN DOOR; HINGE HASP	48	24	18
22-2251H-WH	MILD STEEL BOX; WHITE POWDER COAT; SINGLE, DROP-DOWN DOOR; HINGE HASP	48	24	18
22-2255L-BK	MILD STEEL BOX; BLACK POWDER COAT; DOUBLE SIDE-SWING DOORS; LEFT-DOOR STAINLESS STEEL T-HANDLE LOCK	48	24	18
22-2255L-WH	MILD STEEL BOX; WHITE POWDER COAT; DOUBLE SIDE-SWING DOORS; LEFT-DOOR STAINLESS STEEL T-HANDLE LOCK	48	24	18
22-2255R-BK	MILD STEEL BOX; BLACK POWDER COAT; DOUBLE SIDE-SWING DOORS; RIGHT-DOOR STAINLESS STEEL T-HANDLE LOCK	48	24	18
22-2255R-WH	MILD STEEL BOX; WHITE POWDER COAT; DOUBLE SIDE-SWING DOORS; RIGHT-DOOR STAINLESS STEEL T-HANDLE LOCK	48	24	18
22-2322H-BK	MILD STEEL BOX; BLACK POWDER COAT; SINGLE, DROP-DOWN DOOR; HINGE HASP	60	24	24
22-2322H-WH	MILD STEEL BOX; WHITE POWDER COAT; SINGLE, DROP-DOWN DOOR; HINGE HASP	60	24	24
22-2328B-BK	MILD STEEL BOX; BLACK POWDER COAT; SINGLE, DROP-DOWN DOOR; STAINLESS STEEL T-HANDLE LOCK	60	18	18
22-2328B-WH	MILD STEEL BOX; WHITE POWDER COAT; SINGLE, DROP-DOWN DOOR; STAINLESS STEEL T-HANDLE LOCK	60	18	18
22-2328H-BK	MILD STEEL BOX; BLACK POWDER COAT; SINGLE, DROP-DOWN DOOR; HINGE HASP	60	18	18
22-2328H-WH	MILD STEEL BOX; WHITE POWDER COAT; SINGLE, DROP-DOWN DOOR; HINGE HASP	60	18	18
22-2328SS-BK	MILD STEEL BOX; BLACK POWDER COAT, SINGLE DROP-DOWN STAINLESS DOOR; STAINLESS STEEL T-HANDLE LOCK	60	18	18
22-2328SS-WH	MILD STEEL BOX; WHITE POWDER COAT, SINGLE DROP-DOWN STAINLESS DOOR; STAINLESS STEEL T-HANDLE LOCK	60	18	18
22-2330B-BK	MILD STEEL BOX; BLACK POWDER COAT; SINGLE, DROP-DOWN DOOR; STAINLESS STEEL T-HANDLE LOCK	72	18	18
22-2330B-WH	MILD STEEL BOX; WHITE POWDER COAT; SINGLE, DROP-DOWN DOOR; STAINLESS STEEL T-HANDLE LOCK	72	18	18

MEDIUM-DUTY TO CLASS-8

STEEL TOOLBOXES (Continued)		W"	D"	H"
22-2332B-BK	MILD STEEL BOX; BLACK POWDER COAT; SINGLE, DROP-DOWN DOOR; STAINLESS STEEL T-HANDLE LOCK	60	24	24
22-2332B-WH	MILD STEEL BOX; WHITE POWDER COAT; SINGLE, DROP-DOWN DOOR; STAINLESS STEEL T-HANDLE LOCK	60	24	24
22-2335L-BK	MILD STEEL BOX; BLACK POWDER COAT; DOUBLE SIDE-SWING DOORS; LEFT-DOOR STAINLESS STEEL T-HANDLE LOCK	60	24	24
22-2335L-WH	MILD STEEL BOX; WHITE POWDER COAT; DOUBLE SIDE-SWING DOORS; LEFT-DOOR STAINLESS STEEL T-HANDLE LOCK	60	24	24
22-2335R-BK	MILD STEEL BOX; BLACK POWDER COAT; DOUBLE SIDE-SWING DOORS; RIGHT-DOOR STAINLESS STEEL T-HANDLE LOCK	60	24	24
22-2335R-WH	MILD STEEL BOX; WHITE POWDER COAT; DOUBLE SIDE-SWING DOORS; RIGHT-DOOR STAINLESS STEEL T-HANDLE LOCK	60	24	24
22-2338L-BK	MILD STEEL BOX; BLACK POWDER COAT; DOUBLE SIDE-SWING DOORS; LEFT-DOOR STAINLESS STEEL T-HANDLE LOCK	60	18	18
22-2338L-WH	MILD STEEL BOX; WHITE POWDER COAT; DOUBLE SIDE-SWING DOORS; LEFT-DOOR STAINLESS STEEL T-HANDLE LOCK	60	18	18
22-2338R-BK	MILD STEEL BOX; BLACK POWDER COAT; DOUBLE SIDE-SWING DOORS; RIGHT-DOOR STAINLESS STEEL T-HANDLE LOCK	60	18	18
22-2338R-WH	MILD STEEL BOX; WHITE POWDER COAT; DOUBLE SIDE-SWING DOORS; RIGHT-DOOR STAINLESS STEEL T-HANDLE LOCK	60	18	18
22-2342B-BK	MILD STEEL BOX; BLACK POWDER COAT; SINGLE, DROP-DOWN DOOR; STAINLESS STEEL T-HANDLE LOCK	72	24	24
22-2342B-WH	MILD STEEL BOX; WHITE POWDER COAT; SINGLE, DROP-DOWN DOOR; STAINLESS STEEL T-HANDLE LOCK	72	24	24
22-2345L-BK	MILD STEEL BOX; BLACK POWDER COAT; DOUBLE SIDE-SWING DOORS; LEFT-DOOR STAINLESS STEEL T-HANDLE LOCK	72	24	24
22-2345L-WH	MILD STEEL BOX; WHITE POWDER COAT; DOUBLE SIDE-SWING DOORS; LEFT-DOOR STAINLESS STEEL T-HANDLE LOCK	72	24	24
22-2345R-BK	MILD STEEL BOX; BLACK POWDER COAT; DOUBLE SIDE-SWING DOORS; RIGHT-DOOR STAINLESS STEEL T-HANDLE LOCK	72	24	24

STEEL TOOLBOXES (Continued)		W"	D"	H"
22-2345R-WH	MILD STEEL BOX; WHITE POWDER COAT; DOUBLE SIDE-SWING DOORS; RIGHT-DOOR STAINLESS STEEL T-HANDLE LOCK	72	24	24
22-2348L-BK	MILD STEEL BOX; BLACK POWDER COAT; DOUBLE SIDE-SWING DOORS; LEFT-DOOR STAINLESS STEEL T-HANDLE LOCK	72	18	18
22-2348L-WH	MILD STEEL BOX; WHITE POWDER COAT; DOUBLE SIDE-SWING DOORS; LEFT-DOOR STAINLESS STEEL T-HANDLE LOCK	72	18	18
22-2348R-BK	MILD STEEL BOX; BLACK POWDER COAT; DOUBLE SIDE-SWING DOORS; RIGHT-DOOR STAINLESS STEEL T-HANDLE LOCK	72	18	18
22-2348R-WH	MILD STEEL BOX; WHITE POWDER COAT; DOUBLE SIDE-SWING DOORS; RIGHT-DOOR STAINLESS STEEL T-HANDLE LOCK	72	18	18
22-2350B-BK	MILD STEEL BOX; BLACK POWDER COAT; SINGLE, DROP-DOWN DOOR; STAINLESS STEEL T-HANDLE LOCK	60	24	18
22-2350B-WH	MILD STEEL BOX; WHITE POWDER COAT; SINGLE, DROP-DOWN DOOR; STAINLESS STEEL T-HANDLE LOCK	60	24	18
22-2351H-BK	MILD STEEL BOX; BLACK POWDER COAT; SINGLE, DROP-DOWN DOOR; HINGE HASP	60	24	18
22-2351H-WH	MILD STEEL BOX; WHITE POWDER COAT; SINGLE, DROP-DOWN DOOR; HINGE HASP	60	24	18
22-2355L-BK	MILD STEEL BOX; BLACK POWDER COAT; DOUBLE SIDE-SWING DOORS; LEFT-DOOR STAINLESS STEEL T-HANDLE LOCK	60	24	18
22-2355L-WH	MILD STEEL BOX; WHITE POWDER COAT; DOUBLE SIDE-SWING DOORS; LEFT-DOOR STAINLESS STEEL T-HANDLE LOCK	60	24	18
22-2355R-BK	MILD STEEL BOX; BLACK POWDER COAT; DOUBLE SIDE-SWING DOORS; RIGHT-DOOR STAINLESS STEEL T-HANDLE LOCK	60	24	18
22-2355R-WH	MILD STEEL BOX; WHITE POWDER COAT; DOUBLE SIDE-SWING DOORS; RIGHT-DOOR STAINLESS STEEL T-HANDLE LOCK	60	24	18
22-2358B-BK	MILD STEEL BOX; BLACK POWDER COAT; SINGLE, DROP-DOWN DOOR; STAINLESS STEEL T-HANDLE LOCK	72	24	18
22-2358B-WH	MILD STEEL BOX; WHITE POWDER COAT; SINGLE, DROP-DOWN DOOR; STAINLESS STEEL T-HANDLE LOCK	72	24	18

STANDARD STEEL STORAGE BOXES

STEEL TOOLBOXES (Continued)		W"	D"	H"
22-2358L-BK	MILD STEEL BOX; BLACK POWDER COAT; DOUBLE SIDE-SWING DOORS; LEFT-DOOR STAINLESS STEEL T-HANDLE LOCK	72	24	18
22-2358L-WH	MILD STEEL BOX; WHITE POWDER COAT; DOUBLE SIDE-SWING DOORS; LEFT-DOOR STAINLESS STEEL T-HANDLE LOCK	72	24	18
22-2358R-BK	MILD STEEL BOX; BLACK POWDER COAT; DOUBLE SIDE-SWING DOORS; RIGHT-DOOR STAINLESS STEEL T-HANDLE LOCK	72	24	18
22-2358R-WH	MILD STEEL BOX; WHITE POWDER COAT; DOUBLE SIDE-SWING DOORS; RIGHT-DOOR STAINLESS STEEL T-HANDLE LOCK	72	24	18
22-2431-BK	MILD STEEL BOX; BLACK POWDER COAT; SLOPE-TOP; TOP-OPEN LID; HINGE HASP	24	18	18
22-2431-WH	MILD STEEL BOX; WHITE POWDER COAT; SLOPE-TOP; TOP-OPEN LID; HINGE HASP	24	18	18
22-2432-BK	MILD STEEL BOX; BLACK POWDER COAT; FLAT-TOP; TOP-OPEN LID; HINGE HASP	24	18	18
22-2432-WH	MILD STEEL BOX; WHITE POWDER COAT; FLAT-TOP; TOP-OPEN LID; HINGE HASP	24	18	18
22-2433-BK	MILD STEEL BOX; BLACK POWDER COAT; FLAT-TOP; TOP-OPEN LID; HINGE HASP	48	24	24
22-2433-WH	MILD STEEL BOX; WHITE POWDER COAT; FLAT-TOP; TOP-OPEN LID; HINGE HASP	48	24	24
STEEL TOOLBOX SHELVES WITH INSTALLATION		W"	D"	H"
22-2500-18	SHELF FOR STEEL BOX UP TO 18 INCHES WIDE; WELD-IN INSTALLATION			
22-2500-24	SHELF FOR STEEL BOX UP TO 24 INCHES WIDE; WELD-IN INSTALLATION			
22-2500-36	SHELF FOR STEEL BOX 25 TO 36 INCHES WIDE; WELD-IN INSTALLATION			
22-2500-48	SHELF FOR STEEL BOX 37 TO 48 INCHES WIDE; WELD-IN INSTALLATION			
22-2500-60	SHELF FOR STEEL BOX 49 TO 60 INCHES WIDE; WELD-IN INSTALLATION			
22-2500-72	SHELF FOR STEEL BOX 61 TO 72 INCHES WIDE; WELD-IN INSTALLATION			
STEEL TOOLBOX MOUNTING BRACKETS		W"	D"	H"
20-9700	BRACKETS FOR 24" DEEP BOX			
20-9710	BRACKETS FOR 18" DEEP BOX			
20-9720	BRACKETS FOR 30" DEEP BOX			

GROVE™ DRAWER MODULE



STORAGE BOX DRAWER INSERTS

Our design allows drawer heights as low as 2" that allow gloved fingers to trigger the latch release. The drawer handles are recessed flush with the cabinet housing to eliminate snagging clothes or equipment. Slides have hardened steel balls that ride in steel channels. With the industrial-grade Groove drawer module, the drawer handle stays put and the ProTech proprietary design trigger release does the work.



KEY POINTS

- Gloved hands have plenty of room to access the drawer's trigger release
- Drawer heights from 2" to 7"
- Drawer widths up to 48" and depths to 28" with 100% extension with 250-pound rated load drawer slides
- Corner welds keep the drawer stable.
- Drawer catch hooks are high-wear zinc alloy, not plastic.
- Groove drawer modules come with a 5-year limited warranty.



MEDIUM-DUTY TO CLASS-8

PROTECH FENDERS. GOOD LOOKS - BUILT FOR TRUCKS WITH A JOB TO DO.

Polished Aluminum. 304 Stainless. Mill Finish. Aluminum. Ribbed. Smooth. Diamond plate. Half. Full. Quarter. Single. And the brackets to keep them in place.

FEATURES



CUSTOM LOOK. DURABLE PERFORMANCE.

Fenders come in a variety of styles, manufactured in standard configurations



SHOWN: 30-7352

Half-circle, single axle fender; smooth, 0.112" aluminum. 25"W x 49" Tip-to-tail x 25"H

KEY POINTS

- ProTech offers over 100 fender configurations, from heavy-service fenders to flat fenders and the brackets to keep them in place.
- Fender kits that include two fenders and the mounting brackets are offered.

METAL SELECTION

Aluminum fenders are 5052 marine-grade alloy. Polished steel is 304 stainless, with 18% chromium for corrosion resistance and long-lasting high-polish finish. Mild steel offers light weight, with high strength and stiffness. Rib-down fenders are standard.

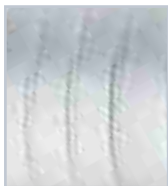

0.090"
**RIBBED &
MILL FINISH
ALUMINUM**



0.105"
**DIAMOND
PLATE
ALUMINUM**



0.112"
**POLISHED
5052
ALUMINUM**



**14 GA
304
STAINLESS
STEEL**



SCOTT INDUSTRIES

ProTech custom fenders (and custom flatbed)

FENDERS SELECTION

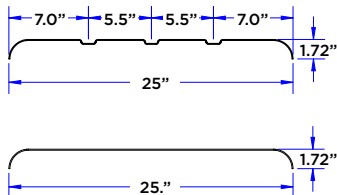

FENDER CROSS SECTIONS

AVAILABLE IN RIBBED & NON-RIBBED.
RIBBED FENDERS are available in 0.090 aluminum mill finish and 14ga mild steel.
NON-RIBBED FENDERS are offered in 0.112 buff aluminum, 0.105 aluminum diamond plate and polished 14ga stainless steel.

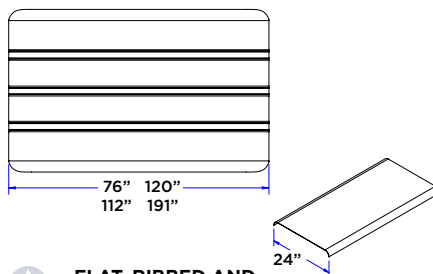

FLAT, RIBBED AND NON-RIBBED

Aluminum flat fenders, with 1" flanges, are available in 76" to 191" Tip- To-Tail lengths.

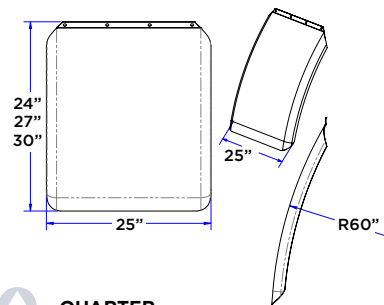

QUARTER

Polished, 14 ga stainless steel; pre-cut, top-flap mounting hole. Available individually or in two-fender kits that includes brackets for Peterbilt Air Leaf, Low Air Leaf, Air Trac and Air Ride; Freightliner Air as well as Kenworth or Other "Clean Frame" Applications.

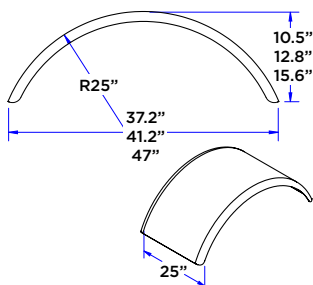

FULL RADIUS, SINGLE AXLE

The 17 full radius, single axle fenders are available in diamond plate, smooth and ribbed aluminum as well as polished stainless and mild steel, with or without ribs.

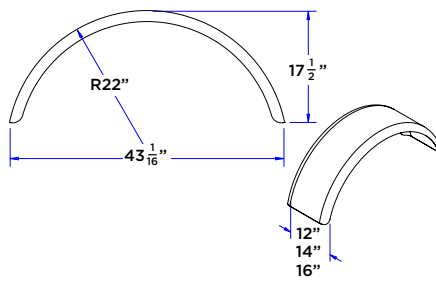

FULL RADIUS, LIFT AXLE, SINGLE TIRE

Protection comes in durable diamond plate and smooth aluminum, as well as polished stainless steel. Also offered is a two-fender kit that includes mounting brackets.

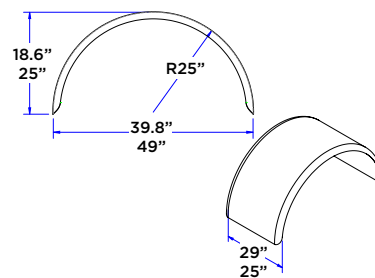

HALF CIRCLE, SINGLE AXLE

Plenty of choices in stainless steel, smooth and ribbed aluminum, diamond plate and mild steel with or without ribs.

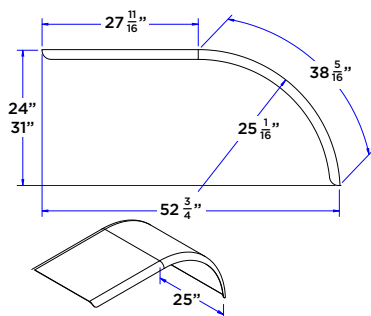

HALF TANDEM, SINGLE RADIUS

Go light with diamond plate, smooth, mill finish and ribbed aluminum. Go bright with polished stainless steel. Or do mild steel with or without ribs. Two-fender kits with mounting brackets are available.

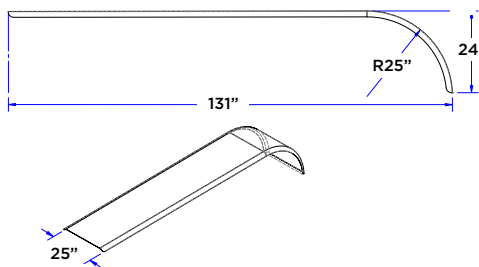

FULL TANDEM, SINGLE RADIUS

Full tandem single radius fenders are available in diamond plate, smooth and ribbed aluminum as well as polished stainless and mild steel with or without ribs.

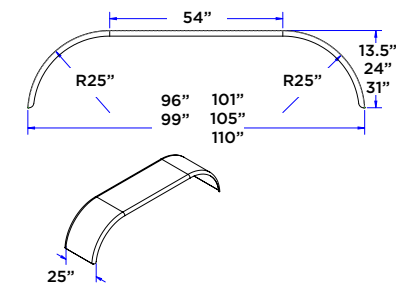

FULL TANDEM, DOUBLE RADIUS

Choose fenders made from diamond plate, smooth or ribbed aluminum, polished stainless or mild steel (with or without ribs) — even extended drop fenders.

MEDIUM-DUTY TO CLASS-8

FLAT FENDERS		TipToTail	D"	H"
30-7314-076	FLAT FENDER; RIBBED, .090 ALUMINUM WITH 1" FLANGES	76	25	1
30-7314-112	FLAT FENDER; RIBBED, .090 ALUMINUM WITH 1" FLANGES	112	25	1
30-7314-120	FLAT FENDER; RIBBED, .090 ALUMINUM WITH 1" FLANGES	120	25	1
30-7314-191	FLAT FENDER; RIBBED, .090 ALUMINUM WITH 1" FLANGES	191	25	1
FULL TANDEM, SINGLE RADIUS		TipToTail	D"	H"
30-7330	FULL TANDEM, SINGLE RADIUS FENDER; DIAMOND PLATE, .105 ALUMINUM	130.8	25	24
30-7332	FULL TANDEM, SINGLE RADIUS FENDER; SMOOTH, .112 ALUMINUM	130.8	25	24
30-7334	FULL TANDEM, SINGLE RADIUS FENDER; RIBBED, .09 ALUMINUM	130.8	25	24
30-7334NR	FULL TANDEM, SINGLE RADIUS FENDER; SMOOTH, .09 ALUMINUM; NO-RIBS	130.8	25	24
30-7337	FULL TANDEM, SINGLE RADIUS FENDER; 14GA, STAINLESS STEEL	130.8	25	24
30-7338	FULL TANDEM, SINGLE RADIUS FENDER; RIBBED, 14 GA MILD STEEL	130.8	25	24
30-7338NR	FULL TANDEM, SINGLE RADIUS FENDER; SMOOTH, 14 GA MILD STEEL; NO RIBS	130.8	25	24
FULL TANDEM, DOUBLE RADIUS FENDER		TipToTail	D"	H"
30-7360	FULL TANDEM, DOUBLE RADIUS FENDER; DIAMOND PLATE, .105 ALUMINUM	105	25	24
30-7360-101	FULL TANDEM, DOUBLE RADIUS FENDER; DIAMOND PLATE, .105 ALUMINUM	101	25	24
30-7362	FULL TANDEM, DOUBLE RADIUS FENDER; SMOOTH, .112 INCH ALUMINUM	105	25	24
30-7362-101	FULL TANDEM, DOUBLE RADIUS FENDER; SMOOTH, .112 INCH ALUMINUM	101	25	24
30-7362-6F	FULL TANDEM, DOUBLE RADIUS DROP FENDER EXTENDED 6 INCHES; SMOOTH, .112 ALUMINUM	101	25	31
30-7364	FULL TANDEM, DOUBLE RADIUS FENDER; RIBBED, .09 MILL-FINISH ALUMINUM	101	25	24
30-7364-101	FULL TANDEM, DOUBLE RADIUS FENDER; RIBBED, .09 MILL-FINISH ALUMINUM	101	25	24
30-7364-B18	FULL TANDEM, DOUBLE RADIUS FENDER; SMOOTH, .09 MILL-FINISH ALUMINUM; NO RIBS	99	25	13.5
30-7364-B96	FULL TANDEM, DOUBLE RADIUS FENDER; RIBBED, .09 MILL-FINISH ALUMINUM	96	25	13.5

FULL TANDEM, DOUBLE RADIUS FENDER (Continued)		TipToTail	D"	H"
30-7364NR	FULL TANDEM, DOUBLE RADIUS FENDER; SMOOTH, .09 MILL-FINISH ALUMINUM; NO RIBS	105	25	24
30-7367	FULL TANDEM, DOUBLE RADIUS FENDER; 14 GA POLISHED STAINLESS STEEL	105	25	24
30-7367-101	FULL TANDEM, DOUBLE RADIUS FENDER; 14 GA POLISHED STAINLESS STEEL	101	25	24
30-7367-6F	FULL TANDEM, DOUBLE RADIUS FENDER EXTENDED 6 INCHES; 14 GA POLISHED STAINLESS STEEL	105	25	31
30-7368	FULL TANDEM, DOUBLE RADIUS FENDER; RIBBED, 14 GA MILD STEEL	105	25	24
30-7368NR	FULL TANDEM, DOUBLE RADIUS FENDER; SMOOTH, 14 GA MILD STEEL; NO RIBS	105	25	24
30-7380	FULL TANDEM, DOUBLE RADIUS FENDER; DIAMOND PLATE, .105 ALUMINUM	110	25	24
HALF TANDEM SINGLE RADIUS FENDER		TipToTail	D"	H"
30-7320	HALF TANDEM, SINGLE RADIUS FENDER; DIAMOND PLATE, .105 ALUMINUM	52.75	25	24
30-7322	HALF TANDEM, SINGLE RADIUS FENDER; SMOOTH, .112 ALUMINUM	52.75	25	24
30-7322-6F	HALF TANDEM, SINGLE RADIUS FENDER, EXTENDED 6 INCHES; SMOOTH, .112 ALUMINUM	52.75	25	31
30-7324	HALF TANDEM, SINGLE RADIUS FENDER; RIBBED, .090 ALUMINUM	52.75	25	24
30-7324NR	HALF TANDEM, SINGLE RADIUS FENDER; SMOOTH, .090 ALUMINUM; NO RIBS	52.75	25	24
30-7327	HALF TANDEM, SINGLE RADIUS FENDER; POLISHED 14 GA STAINLESS STEEL	52.75	25	24
30-7327-6F	HALF TANDEM, SINGLE RADIUS FENDER, EXTENDED 6 INCHES; POLISHED 14 GA STAINLESS STEEL	52.75	25	31
30-7328	HALF TANDEM, SINGLE RADIUS FENDER; RIBBED, 14 GA MILD STEEL	52.75	25	24
30-7328NR	HALF TANDEM, SINGLE RADIUS FENDER; SMOOTH, 14 GA. MILD STEEL; NO RIBS	52.75	25	24
FULL RADIUS, LIFT AXLE SINGLE TIRE FENDERS		TipToTail	D"	H"
30-7240-12	FULL RADIUS, LIFT AXLE SINGLE TIRE FENDER; DIAMOND PLATE, .105 ALUMINUM	43	12	17.5
30-7240-14	FULL RADIUS, LIFT AXLE SINGLE TIRE FENDER; DIAMOND PLATE, .105 ALUMINUM	43	14	17.5

FULL RADIUS, LIFT AXLE SINGLE TIRE FENDERS (Continued)		TipToTail	D"	H"
30-7240-16	FULL RADIUS, LIFT AXLE SINGLE TIRE FENDER; DIAMOND PLATE, .105 ALUMINUM	43	16	17.5
30-7242-12	FULL RADIUS, LIFT AXLE SINGLE TIRE FENDER; SMOOTH, .112 ALUMINUM	43	12	17.5
30-7242-14	FULL RADIUS, LIFT AXLE SINGLE TIRE FENDER; SMOOTH, .112 ALUMINUM	43	14	17.5
30-7242-16	FULL RADIUS, LIFT AXLE SINGLE TIRE FENDER; SMOOTH, .112 ALUMINUM	43	16	17.5
30-7247-12	FULL RADIUS, LIFT AXLE SINGLE TIRE FENDER; POLISHED, 14 GA STAINLESS STEEL	43	12	17.5
30-7247-14	FULL RADIUS, LIFT AXLE SINGLE TIRE FENDER; POLISHED, 14 GA STAINLESS STEEL	43	14	17.5
30-7247-16	FULL RADIUS, LIFT AXLE SINGLE TIRE FENDER; POLISHED, 14 GA STAINLESS STEEL	43	16	17.5
FULL RADIUS, SINGLE AXLE FENDERS		TipToTail	D"	H"
30-7140	FULL RADIUS, 20 INCH, SINGLE AXLE FENDER; DIAMOND PLATE, .105 ALUMINUM	37.2	20	12.8
30-7142	FULL RADIUS, 20 INCH, SINGLE AXLE FENDER; SMOOTH, .112 ALUMINUM	37.2	20	12.8
30-7147	FULL RADIUS, 20 INCH, SINGLE AXLE FENDER; POLISHED, 14 GA STAINLESS STEEL	37.2	20	12.8
30-7340	FULL RADIUS, SINGLE AXLE FENDER; DIAMOND PLATE, .105 ALUMINUM	47	25	15.6
30-7340-48	FULL RADIUS, SINGLE AXLE FENDER; DIAMOND PLATE, .105 ALUMINUM	41.2	25	10.5
30-7342	FULL RADIUS, SINGLE AXLE FENDER; SMOOTH, .112 ALUMINUM	47	25	15.6
30-7342-48	FULL RADIUS, SINGLE AXLE FENDER; SMOOTH, .112 INCH ALUMINUM	41.2	25	10.5
30-7344	FULL RADIUS, SINGLE AXLE FENDER; SMOOTH, .09 ALUMINUM; WITH RIBS	47	25	15.6
30-7344-48	FULL RADIUS, SINGLE AXLE FENDER; SMOOTH, .09 ALUMINUM; WITH RIBS	41.2	25	10.5
30-7344NR	FULL RADIUS, SINGLE AXLE FENDER; SMOOTH, .09 ALUMINUM; NO RIBS	47	25	15.6
30-7344NR-48	FULL RADIUS, SINGLE AXLE FENDER; SMOOTH, .09 ALUMINUM; NO RIBS	41.2	25	10.5
30-7347	FULL RADIUS, SINGLE AXLE FENDER; POLISHED, 14 GA STAINLESS STEEL	47	25	15.6

FULL RADIUS, SINGLE AXLE FENDERS (Continued)		TipToTail	D"	H"
30-7347-48	FULL RADIUS, SINGLE AXLE FENDER; POLISHED, 14 GA STAINLESS STEEL	41.2	25	10.5
30-7348	FULL RADIUS, SINGLE AXLE FENDER; RIBBED, 14 GA MILD STEEL, UNPAINTED	47	25	15.6
30-7348-48	FULL RADIUS, SINGLE AXLE FENDER; RIBBED, 14 GA MILD STEEL, UNPAINTED	41.2	25	10.5
30-7348NR	FULL RADIUS, SINGLE AXLE FENDER; SMOOTH, 14 GA MILD STEEL, UNPAINTED; NO RIBS	47	25	15.6
30-7348NR-48	FULL RADIUS, SINGLE AXLE FENDER; SMOOTH, 14 GA MILD STEEL, UNPAINTED; NO RIBS	41.2	25	10.5
HALF CIRCLE, SINGLE AXLE FENDERS		TipToTail	D"	H"
30-7150	HALF CIRCLE, SINGLE AXLE FENDER; DIAMOND PLATE, .105, ALUMINUM	39.8	20	18.6
30-7152	HALF CIRCLE, SINGLE AXLE FENDER; SMOOTH, 0.112 ALUMINUM	39.8	20	18.6
30-7157	HALF CIRCLE, SINGLE AXLE FENDER; 14GA, POLISHED STAINLESS STEEL	39.8	20	18.6
30-7350	HALF CIRCLE, SINGLE AXLE FENDER; DIAMOND PLATE, .105 ALUMINUM	49	25	25
30-7352	HALF CIRCLE, SINGLE AXLE FENDER; SMOOTH, .112 ALUMINUM	49	25	25
30-7354	HALF CIRCLE, SINGLE AXLE FENDER; RIBBED, .09 ALUMINUM	49	25	25
30-7354NR	HALF CIRCLE, SINGLE AXLE FENDER; SMOOTH, .09 ALUMINUM; NO RIBS	49	25	25
30-7357	HALF CIRCLE, SINGLE AXLE FENDER; POLISHED, 14 GA STAINLESS STEEL	49	25	25
30-7358	HALF CIRCLE, SINGLE AXLE FENDER; RIBBED, 14 GA MILD STEEL, UNPAINTED	49	25	25
30-7358NR	HALF CIRCLE, SINGLE AXLE FENDER; SMOOTH, 14 GA MILD STEEL, UNPAINTED; NO RIBS	49	25	25
QUARTER FENDER		TipToTail	D"	H"
30-7317-24	QUARTER FENDER; POLISHED, 14 GA STAINLESS STEEL; 60-INCH RADIUS; PRE-CUT, TOP-FLAP MOUNTING HOLES	24	25	2
30-7317-27	QUARTER FENDER; POLISHED, 14 GA STAINLESS STEEL; 60-INCH RADIUS; PRE-CUT, TOP-FLAP MOUNTING HOLES	27	25	2.5
30-7317-30	QUARTER FENDER; POLISHED, 14 GA STAINLESS STEEL; 60-INCH RADIUS; PRE-CUT, TOP-FLAP MOUNTING HOLES	30	25	3

MEDIUM-DUTY TO CLASS-8

FENDER KITS — TWO FENDERS WITH BRACKETS INCLUDED		TipToTail	D"	H"
30-7318	FULL RADIUS, LIFT AXLE, SINGLE TIRE FENDER; DIAMOND PLATE ALUMINUM; MOUNTING BRACKETS INCLUDED	40	20	9
30-7319-27F	QUARTER FENDERS (QTY 2 OF 30-7317-27); STAINLESS STEEL MOUNTING BRACKETS INCLUDED; FOR PETERBILT AIR LEAF, LOW AIR LEAF, AND FREIGHTLINER AIR	27	25	2
30-7319-27K	QUARTER FENDERS (QTY 2 OF 30-7317-27); STAINLESS STEEL MOUNTING BRACKETS INCLUDED; FOR KENWORTH AND OTHER "CLEAN FRAME" APPLICATIONS	27	25	2
30-7319-27P	QUARTER FENDERS (QTY 2 OF 30-7317-27); STAINLESS STEEL MOUNTING BRACKETS INCLUDED; FOR PETERBILT AIR TRAC OR AIR RIDE	27	25	2
30-7319-30F	QUARTER FENDERS (QTY 2 OF 30-7317-30); STAINLESS STEEL MOUNTING BRACKETS INCLUDED; FOR PETERBILT AIR LEAF, LOW AIR LEAF, AND FREIGHTLINER AIR	30	25	2
30-7319-30K	QUARTER FENDERS (QTY 2 OF 30-7317-30); STAINLESS STEEL MOUNTING BRACKETS INCLUDED; FOR KENWORTH AND OTHER "CLEAN FRAME" APPLICATIONS	30	25	2
30-7319-30P	QUARTER FENDERS (QTY 2 OF 30-7317-30); STAINLESS STEEL MOUNTING BRACKETS INCLUDED; FOR PETERBILT AIR TRAC OR AIR RIDE	30	25	2
30-7427F	HALF TANDEM FENDERS (QTY 2 OF 30-7327); STAINLESS STEEL MOUNTING BRACKETS INCLUDED; FOR PETERBILT AIR LEAF, LOW AIR LEAF AND FREIGHTLINER AIR	52.8	25	24
30-7427K	HALF TANDEM FENDERS (QTY 2 OF 30-7327); STAINLESS STEEL MOUNTING BRACKETS INCLUDED; FOR KENWORTH AND OTHER "CLEAN FRAME" APPLICATIONS	52.8	25	24
30-7427P	HALF TANDEM FENDERS (QTY 2 OF 30-7327); STAINLESS STEEL MOUNTING BRACKETS INCLUDED; FOR PETERBILT AIR TRAC OR AIR RIDE	52.8	25	24

FENDER BRACKETS

How to select your fender bracket options

- ProTech fender brackets are sold individually as well as in two-fender kits. Be sure to order correctly
- Choose either black powder coat steel or stainless steel
- Select the appropriate configuration:
 - Under-side bracket- black powder coat/adjustable galvanized rise plate
 - Under-side single stud center fender mounting bracket
 - Outer fender bracket
 - Peterbilt® Air Track Suspension bracket
 - Universal Air Leaf mounting bracket (Peterbilt/Freightliner/Low Air Leaf)
 - Single-bolt fender mounting bracket



SHOWN: 30-7391S

Stainless steel bracket for clean frames



SHOWN: 30-7393LS

Stainless steel bracket for Peterbilt Air Trac Suspension



SHOWN: 30-7394-50S

Stainless steel bracket for multiple applications



SHOWN: 30-7590

Powder coated mild steel bracket for OTR applications



SHOWN: 30-7525

Bracket with adjustable riser plate for OTR applications



SHOWN: 30-7395L

Heavy-service bracket for off-road applications

NOTE: Fender mounting brackets are sold individually as well as in pairs that mount two fenders — fenders are not included.



PETERBILT TRUCK WITH LOW AIR LEAF SUSPENSION

Shown: ProTech bracket with adjustable riser plate

FENDERS AND FENDER MOUNTING

MOUNTING BRACKETS — INDIVIDUAL	
30—7319—93L	QUARTER FENDER; SINGLE MOUNTING BRACKET, LEFT SIDE; POLISHED, 12 GA STAINLESS STEEL; FOR PETERBILT AIR TRAC OR AIR RIDE SUSPENSION
30—7319—93R	QUARTER FENDER; SINGLE MOUNTING BRACKET, RIGHT SIDE; POLISHED, 12 GA STAINLESS STEEL; FOR PETERBILT AIR TRAC OR AIR RIDE SUSPENSION
30—7391	OUTER FENDER; SINGLE MOUNTING BRACKET, ROUND BASE MOUNT; BLACK POWDER COAT, 14 GA MILD STEEL; FOR CLEAN FRAME MOUNTING APPLICATIONS
30—7391S	OUTER FENDER; SINGLE MOUNTING BRACKET, ROUND BASE 4-BOLT; POLISHED, 12 GA STAINLESS STEEL; FOR CLEAN FRAME MOUNTING APPLICATIONS
30—7393L	OUTER FENDER; SINGLE MOUNTING BRACKET, LEFT SIDE; BLACK POWDER COAT, 14 GA MILD STEEL; FOR PETERBILT AIR TRAC SUSPENSION
30—7393R	OUTER FENDER; SINGLE MOUNTING BRACKET, RIGHT SIDE; BLACK POWDER COAT, 14 GA MILD STEEL; FOR PETERBILT AIR TRAC SUSPENSION
30—7393LS	OUTER FENDER; SINGLE MOUNTING BRACKET, LEFT SIDE; POLISHED, 12 GA STAINLESS STEEL; FOR PETERBILT AIR TRAC SUSPENSION
30—7393RS	OUTER FENDER; SINGLE MOUNTING BRACKET, RIGHT SIDE; POLISHED, 12 GA STAINLESS STEEL; FOR PETERBILT AIR TRAC SUSPENSION
30—7394—50	OUTER FENDER; SINGLE MOUNTING BRACKET, WITH SPACERS; BLACK POWDER COAT, 14 GA MILD STEEL; FOR MULTIPLE APPLICATIONS, PETERBILT AIR LEAF, LOW AIR LEAF AND FREIGHTLINER AIR LEAF
30—7394—50S	OUTER FENDER; SINGLE MOUNTING BRACKET, WITH SPACERS; POLISHED, 12 GA STAINLESS STEEL; FOR MULTIPLE APPLICATIONS, PETERBILT AIR LEAF, LOW AIR LEAF AND FREIGHTLINER AIR LEAF
30—7394—50H	OUTER FENDER; SINGLE MOUNTING BRACKET, WITH SPACERS; BLACK POWDER COAT, 14 GA MILD STEEL; FOR HENDRICKSON AIR RIDE APPLICATIONS
30—7394—50HS	OUTER FENDER; SINGLE MOUNTING BRACKET, WITH SPACERS; POLISHED, 12 GA STAINLESS STEEL; FOR HENDRICKSON AIR RIDE APPLICATIONS
30—7395L	HEAVY-SERVICE FENDER; SINGLE, UNDERSIDE MOUNTING BRACKET, LEFT SIDE
30—7395R	HEAVY-SERVICE FENDER; SINGLE, UNDERSIDE MOUNTING BRACKET, RIGHT SIDE
30—7397S	SINGLE FENDER; SINGLE MOUNTING BRACKET; POLISHED, 12 GA STAINLESS STEEL; FOR PETERBILT FLEX AIR APPLICATIONS
30—7397LS	SINGLE FENDER; SINGLE MOUNTING BRACKET, LEFT SIDE; POLISHED, 12 GA STAINLESS STEEL; FOR PETERBILT FLEX AIR APPLICATIONS
30—7397RS	SINGLE FENDER; SINGLE MOUNTING BRACKET, RIGHT SIDE; POLISHED, 12 GA STAINLESS STEEL; FOR PETERBILT FLEX AIR APPLICATIONS
30—7398LS	SINGLE FENDER; SINGLE MOUNTING BRACKET, LEFT SIDE; POLISHED, 12 GA STAINLESS STEEL; FOR PETERBILT LOW-LOW AIR LEAF APPLICATIONS
30—7398RS	SINGLE FENDER; SINGLE MOUNTING BRACKET, RIGHT SIDE; POLISHED, 12 GA STAINLESS STEEL; FOR PETERBILT LOW-LOW AIR LEAF APPLICATIONS
30—7525	SINGLE FENDER; SINGLE, UNDERSIDE MOUNTING BRACKET; SINGLE STUD; INCLUDES ADJUSTABLE RISER PLATE AND HARDWARE. OVER THE ROAD TRACTOR ONLY.
30—7590	SINGLE FENDER, SINGLE STUD MOUNTING BRACKET; BLACK POWDER COAT, 14 GA MILD STEEL

MOUNTING KITS — BRACKET PAIRS TO MOUNT TWO FENDERS	
30—7419F	QUARTER FENDER MOUNTING KIT FOR TWO FENDERS; 12 GA STAINLESS STEEL BRACKETS; FOR PETERBILT LOW AIR LEAF, AIR LEAF AND FREIGHTLINER AIR LEAF APPLICATIONS
30—7419K	QUARTER FENDER MOUNTING KIT FOR TWO FENDERS; 12 GA STAINLESS STEEL BRACKETS; FOR KENWORTH AND OTHER CLEAN-MOUNT APPLICATIONS
30—7419P	QUARTER FENDER MOUNTING KIT FOR TWO FENDERS; 12 GA STAINLESS STEEL BRACKETS; FOR PETERBILT AIR TRAC OR AIR RIDE
30—7429F	HALF-TANDEM, SINGLE RADIUS FENDER MOUNTING KIT FOR TWO FENDERS; 12 GA STAINLESS STEEL BRACKETS; FOR PETERBILT LOW AIR LEAF, AIR LEAF AND FREIGHTLINER AIR LEAF APPLICATIONS
30—7429P	HALF-TANDEM, SINGLE RADIUS FENDER MOUNTING KIT FOR TWO FENDERS; 12 GA STAINLESS STEEL BRACKETS; FOR PETERBILT AIR TRAC OR AIR RIDE APPLICATIONS
30—7482	FULL RADIUS FENDER MOUNTING KIT FOR TWO SINGLE AXLE FENDERS; BLACK POWDER COAT, 14 GA MILD STEEL BRACKETS; FOR CLEAN-FRAME MOUNT APPLICATIONS
30—7482S	FULL RADIUS FENDER MOUNTING KIT FOR TWO SINGLE AXLE FENDERS; 12 GA STAINLESS STEEL BRACKETS; FOR CLEAN-FRAME MOUNT APPLICATIONS
30—7484	HALF-TANDEM, SINGLE RADIUS FENDER MOUNTING KIT FOR TWO FENDERS; BLACK POWDER COAT, 14 GA MILD STEEL BRACKETS; FOR CLEAN-FRAME MOUNT APPLICATIONS
30—7484S	HALF-TANDEM, SINGLE RADIUS FENDER MOUNTING KIT FOR TWO FENDERS; 12 GA STAINLESS STEEL BRACKETS; FOR CLEAN-FRAME MOUNT APPLICATIONS
30—7486	FULL-TANDEM, SINGLE RADIUS FENDER MOUNTING KIT FOR TWO FENDERS; BLACK POWDER COAT, 14 GA MILD STEEL BRACKETS; FOR CLEAN-FRAME MOUNT APPLICATIONS
30—7486S	FULL-TANDEM, SINGLE RADIUS FENDER MOUNTING KIT FOR TWO FENDERS; 12 GA STAINLESS STEEL BRACKETS; FOR CLEAN-FRAME MOUNT APPLICATIONS
30—7488	FULL-TANDEM, DOUBLE RADIUS FENDER MOUNTING KIT FOR TWO FENDERS; BLACK POWDER COAT, 14 GA MILD STEEL BRACKETS; FOR CLEAN-FRAME MOUNT APPLICATIONS
30—7488S	FULL-TANDEM, DOUBLE RADIUS FENDER MOUNTING KIT FOR TWO FENDERS; 12 GA STAINLESS STEEL BRACKETS; FOR CLEAN-FRAME MOUNT APPLICATIONS

PICKUP TRUCK

PROTECH PICKUP TOOLBOXES

Keep the weather out and the tools in. Dense, steel-grip neoprene bulb weather seals. Full-length, load-bearing bottom edge welds won't crack under pressure.

FEATURES

At ProTech, our primary interest is to give truck owners the most functional, durable and the longest life for their toolbox investment. It also happens to be the best looking.



CROSS-BODY BOX 54-8223
Smooth, Buffed Aluminum Lid

NEOPRENE BULB WEATHERPROOF SEALS



VISIBLE WELDS ARE FULL-LENGTH TIG SEAM WELDS

Double-tuck lid hinge mounting eliminates water collection entry points to keep box dry



ZERO CLEARANCE LID OPENING

Allows flush installation in truck box



LID STIFFENER

Adds strength, keeps lid square and warp-free

POWERFUL GAS SHOCKS

Lift lid completely open

FULL LID-LENGTH STAINLESS PIANO HINGE

Weight bearing and attached with self-piercing rivets that retain lid alignment



LARGE TRAY WITH EASY SLIDING RUBBER GLIDERS

CAM-LOCK LINKAGE ARM

Locks-out both handles for security or allows single-handed opening and closing

KEY POINT

The deflection point of ProTech 0.125" 5052 marine grade aluminum is within 10% of 14 GA cold rolled steel. Essentially, it is comparable to steel in strength yet weighs 33% less.



RAFTER 9X RANCH

ProTech 54-8211 toolbox

TOOLBOXES

CROSS-BODY BOXES

Cross body boxes are available for all major models of pickup trucks. Applications include standard dimensions, low profile, extra-wide, extra-deep and extra-wide/extra-deep boxes in single and dual-lid versions. A sliding tray, with rubber gliders, is included in ProTech cross-body boxes.



↑ **DUAL LID CROSS BODY**

SHOWN: 54-8214 Cross body box; full size; dual, polished 0.112 aluminum lids; smooth 0.112 aluminum body; now includes mounting kit!; fit: full size Chevy, Dodge, Ford 1973-1998, Ford F150, Toyota Tundra 2007-2014



↑ **SINGLE LID CROSS BODY**

SHOWN: 54-8211LP-BK Cross body box; full size; single, 0.105 diamond plate lid; smooth 0.112 aluminum body; now includes mounting kit!; Fit: full size Chevy, Dodge, Ford 1973-1998, Ford F150, Toyota Tundra 2007-2014

STANDARD POWDER COAT COLORS

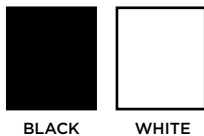

BLACK

WHITE



↑ **IN-BED CHEST-STYLE BOXES**

SHOWN: 54-8440 Maximized depth, available for short beds, long beds and with v-notch.



↑ **DROP-DOOR SIDE RAIL BOXES**

SHOWN: 54-8680-72 Available in aluminum or steel from 48" to 90" in length, in single or dual drop doors depending on box length.



↑ **TOP-OPEN, DROP-DOOR CONTRACTOR BOXES**

SHOWN: 54-7860 Available in lengths of 48"/60"/72"/84" and 96".



↑ **WHEEL-WELL BOXES**

SHOWN: 54-7545 L/R Available in driver's side and passenger-side configurations, with diamond plate or smooth lids



↑ **SIDE RAIL BOXES**

SHOWN: 54-8666-60 Available in lengths from 36" to 90" and widths of 12" or 16".



↑ **TOP OPENING TRAILER TONGUE BOXES**

SHOWN: 54-7218 The wedge box is available in three front widths: 18-3/16", 13-3/16" and 7-5/8", and a diamond plate lid.

PICKUP TRUCK TOOLBOX FITMENT GUIDE

		CROSS BODY TOOLBOXES				EXTRA DEEP CROSS BODY BOXES				IN-BED BOXES	
CHEVROLET & GMC		Single/ Diamond Plate Lid	Single/ Smooth Lid	Dual/ Diamond Plate Lids	Dual/ Smooth Lids	Single/ Diamond Plate Lid	Single/ Smooth Lid	Dual/ Diamond PlateLids	Dual/ Smooth Lids	Diamond Plate Lid	Smooth Lid
SILVERADO/SIERRA (FULL SIZE)											
2007 - 2017	8' Box; 6 1/2' Box	54-8211	54-8213	54-8212	54-8214	54-8011	54-8013	54-8012	54-8014	54-8441	54-8443
	5 1/2' Box	54-8211	54-8213	54-8212	54-8214	Custom	Custom	Custom	Custom	54-8420-20	54-8426-20
1999 - 2006	8' Box; 6 1/2' Box	54-8211	54-8213	54-8212	54-8214	54-8011	54-8013	54-8012	54-8014	54-8440	54-8446
	5 1/2' Box	54-8211	54-8213	54-8212	54-8214	Custom	Custom	Custom	Custom	Custom	Custom
1988 - 1998	8' Box	54-8211	54-8213	54-8212	54-8214	54-8011	54-8013	54-8012	54-8014	54-8440	54-8446
	6 1/2' Box	54-8211	54-8213	54-8212	54-8214	54-8011	54-8013	54-8012	54-8014	54-8420	54-8426
COLORADO/CANYON											
2004 - 2014	Crew Cab	54-8281	54-8283	54-8282	54-8284	Custom	Custom	Custom	Custom	Custom	Custom
	Extended Cab	54-8281	54-8283	54-8282	54-8284	Custom	Custom	Custom	Custom	54-8471	54-8473
S10/S15/SONOMA											
1985 - 2003	All (Except Step Side)	54-8241	54-8243	54-8242	54-8244	Custom	Custom	Custom	Custom	54-8471	54-8473
FORD											
F250/F350											
2017	8' Box; 6 1/2' Box	54-6221	54-6223	54-6222	54-6224	54-6021	54-6023	54-6022	54-6024	-	-
2008 - 2016	8' Box	54-8221	54-8223	54-8222	54-8224	54-8021	54-8023	54-8022	54-8024	54-8480	54-8486
	6 1/2' Box	54-8221	54-8223	54-8222	54-8224	54-8021	54-8023	54-8022	54-8024	54-8490	54-8496
1999 - 2007	8' Box	54-8221	54-8223	54-8222	54-8224	54-8021	54-8023	54-8022	54-8024	54-8480	54-8486
	6 1/2' Box	54-8221	54-8223	54-8222	54-8224	54-8021	54-8023	54-8022	54-8024	54-8490	54-8496
1973 - 1998	8' Box	54-8211	54-8213	54-8212	54-8214	54-8011	54-8013	54-8012	54-8014	54-8440	54-8446
	6 1/2' Box	54-8211	54-8213	54-8212	54-8214	54-8011	54-8013	54-8012	54-8014	54-8420	54-8426
F150 (EXCLUDING STEP SIDE)											
2004 - 2017	8' Box	54-8211	54-8213	54-8212	54-8214	54-8011	54-8013	54-8012	54-8014	54-8431	54-8433
	6 1/2' Box	54-8211	54-8213	54-8212	54-8214	54-8011	54-8013	54-8012	54-8014	54-8431-20	54-8433-20
	5 1/2' Box	54-8211	54-8213	54-8212	54-8214	Custom	Custom	Custom	Custom	54-8430-20	54-8436-20
1997 - 2003	8' Box; 6 1/2' Box	54-8211	54-8213	54-8212	54-8214	54-8011	54-8013	54-8012	54-8014	54-8430	54-8436
	5 1/2' Box	54-8211	54-8213	54-8212	54-8214	Custom	Custom	Custom	Custom	Custom	Custom
1973 - 1996	8' Box	54-8211	54-8213	54-8212	54-8214	54-8011	54-8013	54-8012	54-8014	54-8440	54-8446
	6 1/2' Box	54-8211	54-8213	54-8212	54-8214	54-8011	54-8013	54-8012	54-8014	54-8420	54-8426
RANGER											
1993 - 2011	All (Except Step Side)	54-8241	54-8243	54-8242	54-8244	Custom	Custom	Custom	Custom	54-8471	54-8473
DODGE & RAM											
2500/3500											
2010 - 2017	8' Box	54-8211	54-8213	54-8212	54-8214	54-8011	54-8013	54-8012	54-8014	54-8440	54-8446
	6 1/2' Box	54-8211	54-8213	54-8212	54-8214	Custom	Custom	Custom	Custom	54-8420	54-8426
2003 - 2009	8' Box	54-8211	54-8213	54-8212	54-8214	54-8011	54-8013	54-8012	54-8014	54-8440	54-8446
	6 1/2' Box	54-8211	54-8213	54-8212	54-8214	Custom	Custom	Custom	Custom	54-8420	54-8426
1973 - 2002	8' Box	54-8211	54-8213	54-8212	54-8214	54-8011	54-8013	54-8012	54-8014	54-8440	54-8446
	6 1/2' Box	54-8211	54-8213	54-8212	54-8214	Custom	Custom	Custom	Custom	54-8420	54-8426
1500											
2009 - 2016	8' Box	54-8211	54-8213	54-8212	54-8214	Custom	Custom	Custom	Custom	54-8440	54-8446
	6 1/2' Box	54-8211	54-8213	54-8212	54-8214	Custom	Custom	Custom	Custom	54-8420	54-8426
	5 1/2' Box	54-8291	54-8293	54-8292	54-8294	Custom	Custom	Custom	Custom	Custom	Custom
	5 1/2' Box w/Ram Box	n/a	n/a	n/a	n/a	n/a	n/a	n/a	n/a	n/a	n/a
2002 - 2008	8' Box	54-8211	54-8213	54-8212	54-8214	54-8011	54-8013	54-8012	54-8014	54-8440	54-8446
	6 1/2' Box	54-8211	54-8213	54-8212	54-8214	Custom	Custom	Custom	Custom	54-8420	54-8426
1973 - 2001	8' Box	54-8211	54-8213	54-8212	54-8214	54-8011	54-8013	54-8012	54-8014	54-8440	54-8446
	6 1/2' Box	54-8211	54-8213	54-8212	54-8214	Custom	Custom	Custom	Custom	54-8420	54-8426
DAKOTA											
1985 - 2011	All	54-8251	54-8253	54-8252	54-8254	Custom	Custom	Custom	Custom	54-8471	54-8473
NISSAN											
TITAN											
2004 - 2014	All	54-8271	54-8273	54-8272	54-8274	Custom	Custom	Custom	Custom	Custom	Custom
FRONTIER											
1998 - 2014	All	54-8251	54-8253	54-8252	54-8254	Custom	Custom	Custom	Custom	Custom	Custom
TOYOTA											
TUNDRA (EXCLUDING STEP SIDE)											
2014	8' Box	54-8211	54-8213	54-8212	54-8214	54-8011	54-8013	54-8012	54-8014	54-8431	54-8433
	6 1/2' Box	54-8211	54-8213	54-8212	54-8214	54-8011	54-8013	54-8012	54-8014	54-8431-20	54-8433-20
	5 1/2' Box	54-8211	54-8213	54-8212	54-8214	Custom	Custom	Custom	Custom	Custom	Custom
2007 - 2013	8' Box	54-8211	54-8213	54-8212	54-8214	54-8011	54-8013	54-8012	54-8014	54-8431	54-8433
	6 1/2' Box	54-8211	54-8213	54-8212	54-8214	54-8011	54-8013	54-8012	54-8014	54-8431-20	54-8433-20
	5 1/2' Box	54-8211	54-8213	54-8212	54-8214	Custom	Custom	Custom	Custom	Custom	Custom
1993 - 2006	All	54-8271	54-8273	54-8272	54-8274	Custom	Custom	Custom	Custom	Custom	Custom
TACOMA											
2005 - 2014	All (Except Step Side)	54-8251	54-8253	54-8252	54-8254	Custom	Custom	Custom	Custom	Custom	Custom
1995 - 2004	All (Except Step Side)	54-8241	54-8243	54-8242	54-8244	Custom	Custom	Custom	Custom	Custom	Custom

CROSS BODY TOOLBOXES

CROSS BODY BOXES — SINGLE LID STANDARD		W"	D"	H"
54—6221LP	CROSS BODY BOX; FULL SIZE; LOW-PROFILE; SINGLE, 0.105 DIAMOND PLATE LID; SMOOTH 0.112 ALUMINUM BODY; FIT: 2017 FORD SUPER DUTY	74	20	16
54—8211	CROSS BODY BOX; FULL SIZE; SINGLE, 0.105 DIAMOND PLATE LID; SMOOTH 0.112 ALUMINUM BODY; NOW INCLUDES MOUNTING KIT!; FIT: FULL SIZE CHEVY, DODGE, FORD 1973-1998, FORD F150, TOYOTA TUNDRA 2007-2014	70	20	15
54—8211—BK	CROSS BODY BOX; FULL SIZE; SINGLE, GLOSS BLACK 0.105 DIAMOND PLATE LID; GLOSS BLACK, 0.112 ALUMINUM BODY; NOW INCLUDES MOUNTING KIT!; FIT: FULL SIZE CHEVY, DODGE, FORD 1973-1998, FORD F150, TOYOTA TUNDRA 2007-2014	70	20	15
54—8211LP	CROSS BODY BOX; FULL SIZE; LOW-PROFILE; SINGLE, 0.105 DIAMOND PLATE LID; SMOOTH 0.112 ALUMINUM BODY; NOW INCLUDES MOUNTING KIT!; FIT: FULL SIZE CHEVY, DODGE, FORD 1973-1998, FORD F150, TOYOTA TUNDRA 2007-2014	70	20	16
54—8211LP—BK	CROSS BODY BOX; FULL SIZE; LOW-PROFILE; SINGLE, GLOSS BLACK 0.105 DIAMOND PLATE LID; GLOSS BLACK, 0.112 ALUMINUM BODY; NOW INCLUDES MOUNTING KIT!; FIT: FULL SIZE CHEVY, DODGE, FORD 1973-1998, FORD F150, TOYOTA TUNDRA 2007-2014	70	20	16
54—8213	CROSS BODY BOX; FULL SIZE; SINGLE, POLISHED 0.112 ALUMINUM LID; SMOOTH 0.112 ALUMINUM BODY; NOW INCLUDES MOUNTING KIT!; FIT: CHEVY, DODGE, FORD F150, TOYOTA TUNDRA	70	20	15
54—8213—BK	CROSS BODY BOX; FULL SIZE; SINGLE, GLOSS BLACK 0.112 ALUMINUM LID; GLOSS BLACK, 0.112 ALUMINUM BODY; NOW INCLUDES MOUNTING KIT!; FIT: CHEVY, DODGE, FORD F150, TOYOTA TUNDRA	70	20	15
54—8213LP	CROSS BODY BOX; FULL SIZE; LOW-PROFILE; SINGLE, POLISHED 0.112 ALUMINUM LID; SMOOTH 0.112 ALUMINUM BODY; NOW INCLUDES MOUNTING KIT!; FIT: FULL SIZE CHEVY, DODGE, FORD 1973-1998, FORD F150, TOYOTA TUNDRA 2007-2014	70	20	16
54—8213LP—BK	CROSS BODY BOX; FULL SIZE; LOW-PROFILE; SINGLE, GLOSS BLACK 0.112 ALUMINUM LID; GLOSS BLACK, 0.112 ALUMINUM BODY; NOW INCLUDES MOUNTING KIT!; FIT: FULL SIZE CHEVY, DODGE, FORD 1973-1998, FORD F150, TOYOTA TUNDRA 2007-2014	70	20	16
54—8221	CROSS BODY BOX; FULL SIZE; SINGLE, 0.105 DIAMOND PLATE LID; SMOOTH 0.112 ALUMINUM BODY; NOW INCLUDES MOUNTING KIT!; FIT: FORD SUPER DUTY 1999-2014	74	20	15

CROSS BODY BOXES — SINGLE LID STANDARD (Continued)		W"	D"	H"
54—8221LP	CROSS BODY BOX; FULL SIZE; LOW PROFILE; SINGLE, 0.105 DIAMOND PLATE LID; SMOOTH 0.112 ALUMINUM BODY; NOW INCLUDES MOUNTING KIT!; FIT: FORD SUPER DUTY 1999-2014	74	20	16
54—8223	CROSS BODY BOX; FULL SIZE; SINGLE, POLISHED 0.112 ALUMINUM LID; SMOOTH 0.112 ALUMINUM BODY; NOW INCLUDES MOUNTING KIT!; FIT: FORD SUPER DUTY 1999-2014	74	20	15
54—8223—BK	CROSS BODY BOX; FULL SIZE; SINGLE, GLOSS BLACK, 0.112 ALUMINUM LID; GLOSS BLACK, 0.112 ALUMINUM BODY; NOW INCLUDES MOUNTING KIT!; FIT: FORD SUPER DUTY 1999-2014	74	20	15
54—8223LP	CROSS BODY BOX; FULL SIZE; LOW-PROFILE; SINGLE, POLISHED, 0.112 ALUMINUM LID; SMOOTH 0.112 ALUMINUM BODY; NOW INCLUDES MOUNTING KIT!; FIT: FORD SUPER DUTY 1999-2014	74	20	16
54—8251	CROSS BODY BOX; FULL SIZE; SINGLE 0.105 DIAMOND PLATE LID; 0.112 ALUMINUM BODY; NOW INCLUDES MOUNTING KIT!; FIT: DODGE DAKOTA, TOYOTA TACOMA 2005-2014, NISSAN FRONTIER	64	20	15
54—8253	CROSS BODY BOX; FULL SIZE; SINGLE, POLISHED 0.112 ALUMINUM LID; SMOOTH 0.112 ALUMINUM BODY; NOW INCLUDES MOUNTING KIT!; FIT: DODGE DAKOTA '95+, TOYOTA TACOMA 2005-2014, NISSAN FRONTIER	64	20	15
54—8271	CROSS BODY BOX; FULL SIZE; SINGLE, 0.105 DIAMOND PLATE LID; GLOSS BLACK 0.112 ALUMINUM BODY; NOW INCLUDES MOUNTING KIT!; FIT: TOYOTA T100, TOYOTA TUNDRA 1999-2006, NISSAN TITAN	67	20	15
54—8273	CROSS BODY BOX; FULL SIZE; SINGLE, POLISHED 0.112 ALUMINUM LID; SMOOTH 0.112 ALUMINUM BODY; NOW INCLUDES MOUNTING KIT!; FIT: TOYOTA T100, TOYOTA TUNDRA 1999-2006, NISSAN TITAN	67	20	15
54—8275	CROSS BODY BOX; FULL SIZE; SINGLE, POLISHED STAINLESS STEEL LID; SMOOTH 0.112 ALUMINUM BODY; NOW INCLUDES MOUNTING KIT!; FIT: TOYOTA T100	67	20	15
54—8291	CROSS BODY BOX; FULL SIZE; SINGLE, 0.105 DIAMOND PLATE LID; SMOOTH 0.112 ALUMINUM BODY; NOW INCLUDES MOUNTING KIT!; FIT: DODGE 1500 (5.5' BED) 2009-2014	70	20	15
54—8293	CROSS BODY BOX; FULL SIZE; SINGLE, POLISHED 0.112 ALUMINUM LID; SMOOTH 0.112 ALUMINUM BODY; NOW INCLUDES MOUNTING KIT!; FIT: DODGE 1500 5-1/2FOOT BED 2009-2014	70	20	15

PICKUP TRUCK

CROSS BODY BOXES FOR SMALL TRUCKS — SINGLE LID		W"	D"	H"
54—8281	CROSS BODY BOX; FULL SIZE; SINGLE, 0.105 DIAMOND PLATE LID; SMOOTH 0.112 ALUMINUM BODY; NOW INCLUDES MOUNTING KIT!; FIT: CHEVY COLORADO, GMC CANYON	62	20	13.5
54—8283	CROSS BODY BOX; FULL SIZE; SINGLE, POLISHED 0.112 ALUMINUM LID; SMOOTH 0.112 ALUMINUM BODY; NOW INCLUDES MOUNTING KIT!; FIT: CHEVY COLORADO, GMC CANYON	62	20	13.5
CROSS BODY BOXES — SINGLE LID EXTRA HEIGHT		W"	D"	H"
54—6021	CROSS BODY BOX; FULL SIZE; EXTRA HEIGHT; SINGLE, 0.105 DIAMOND PLATE LID; SMOOTH 0.112 ALUMINUM BODY; FIT: 2017 FORD SUPER DUTY	74	20	20
54—8013	CROSS BODY BOX; FULL SIZE; EXTRA HEIGHT; SINGLE, POLISHED 0.112 ALUMINUM LID; SMOOTH 0.112 ALUMINUM BODY; NOW INCLUDES MOUNTING KIT!; FIT: CHEVY, DODGE, FORD F150, TOYOTA TUNDRA. [BOX IS 14" BELOW BED RAIL]	70	20	20.4
54—8021	CROSS BODY BOX; FULL SIZE; EXTRA HEIGHT; SINGLE, 0.105 DIAMOND PLATE LID; SMOOTH 0.112 ALUMINUM BODY; NOW INCLUDES MOUNTING KIT!; FIT: FORD SUPER DUTY '99+ [MAY NOT WORK WITH SHORT BED; BOX IS 14" BELOW BED RAIL]	74	20	20.4
54—8023	CROSS BODY BOX; FULL SIZE; EXTRA HEIGHT; SINGLE, POLISHED 0.112 ALUMINUM LID; SMOOTH 0.112 ALUMINUM BODY; NOW INCLUDES MOUNTING KIT!; FIT: 99 FORD [BOX IS 14" BELOW BED RAIL]	74	20	20.4
54—8011	CROSS BODY BOX; FULL SIZE; EXTRA HEIGHT; SINGLE, 0.105 DIAMOND PLATE LID; SMOOTH 0.112 ALUMINUM BODY; NOW INCLUDES MOUNTING KIT!; FIT: CHEVY, DODGE, FORD F150, TOYOTA TUNDRA. [BOX IS 14" BELOW BED RAIL]	70	20	20.4
CROSS BODY BOXES — SINGLE LID EXTRA BREADTH		W"	D"	H"
54—8211—28	CROSS BODY BOX; FULL SIZE; EXTRA BREADTH; SINGLE, 0.105 DIAMOND PLATE LID; SMOOTH 0.112 ALUMINUM BODY; NOW INCLUDES MOUNTING KIT!; FIT: FULL SIZE CHEVY, DODGE, FORD 1973-1998, FORD F150, TOYOTA TUNDRA 2007-2014	70	28	15
54—8213—28	CROSS BODY BOX; FULL SIZE; EXTRA BREADTH; SINGLE, POLISHED 0.112 ALUMINUM LID; SMOOTH 0.112 ALUMINUM BODY; NOW INCLUDES MOUNTING KIT!; FIT: FULL SIZE CHEVY, DODGE, FORD 1973-1998, FORD F150, TOYOTA TUNDRA 2007-2014	70	28	15
54—8221—28	CROSS BODY BOX; FULL SIZE; EXTRA BREADTH; SINGLE, 0.105 DIAMOND PLATE LID; SMOOTH 0.112 ALUMINUM BODY; NOW INCLUDES MOUNTING KIT!; FIT: FORD SUPER DUTY	74	28	15

CROSS BODY BOXES — SINGLE LID EXTRA BREADTH (Continued)		W"	D"	H"
54—8223—28	CROSS BODY BOX; FULL SIZE; EXTRA BREADTH; SINGLE, POLISHED 0.112 ALUMINUM LID; SMOOTH 0.112 ALUMINUM BODY; NOW INCLUDES MOUNTING KIT!; FIT: FORD SUPER DUTY	74	28	15
CROSS BODY BOXES — SINGLE LID EXTRA HEIGHT AND EXTRA BREADTH		W"	D"	H"
54—8011—28	CROSS BODY BOX; FULL SIZE; EXTRA HEIGHT, EXTRA BREADTH; SINGLE, 0.105 DIAMOND PLATE LID; SMOOTH 0.112 ALUMINUM BODY; NOW INCLUDES MOUNTING KIT!; FIT: CHEVY, DODGE, FORD F150	70	28	20.4
54—8013—28	CROSS BODY BOX; FULL SIZE; EXTRA HEIGHT, EXTRA BREADTH; SINGLE, POLISHED 0.112 ALUMINUM LID; SMOOTH 0.112 ALUMINUM BODY; NOW INCLUDES MOUNTING KIT!; FIT: CHEVY, DODGE, FORD F150	70	28	20.4
54—8021—28	CROSS BODY BOX; FULL SIZE; EXTRA HEIGHT, EXTRA BREADTH; SINGLE, 0.105 DIAMOND PLATE LID; SMOOTH 0.112 ALUMINUM BODY; NOW INCLUDES MOUNTING KIT!; FIT: FORD SUPER DUTY '99+ [MAY NOT WORK WITH SHORT BED; BOX IS 14" BELOW BED RAIL]	74	28	20.4
54—8023—28	CROSS BODY BOX; FULL SIZE; EXTRA HEIGHT, EXTRA BREADTH; DUAL, POLISHED 0.112 ALUMINUM LID; SMOOTH 0.112 ALUMINUM BODY; NOW INCLUDES MOUNTING KIT!; FIT: FORD SUPER DUTY [MAY NOT WORK WITH SHORT BED; BOX IS 14" BELOW BED RAIL]	74	28	20.4
CROSS BODY BOXES — DUAL LID		W"	D"	H"
54—8212	CROSS BODY BOX; FULL SIZE; DUAL, 0.105 DIAMOND PLATE LIDS; SMOOTH 0.112 ALUMINUM BODY; NOW INCLUDES MOUNTING KIT!; FIT: FULL SIZE CHEVY, DODGE, FORD 1973-1998, FORD F150, TOYOTA TUNDRA 2007-2014	70	20	15
54—8212—BK	CROSS BODY BOX; FULL SIZE; DUAL, GLOSS BLACK 0.105 DIAMOND PLATE LIDS; GLOSS BLACK 0.112 ALUMINUM BODY; NOW INCLUDES MOUNTING KIT!; FIT: FULL SIZE CHEVY, DODGE, FORD 1973-1998, FORD F150, TOYOTA TUNDRA 2007-2014	70	20	15
54—8214	CROSS BODY BOX; FULL SIZE; DUAL, POLISHED 0.112 ALUMINUM LIDS; SMOOTH 0.112 ALUMINUM BODY; NOW INCLUDES MOUNTING KIT!; FIT: FULL SIZE CHEVY, DODGE, FORD 1973-1998, FORD F150, TOYOTA TUNDRA 2007-2014	70	20	15
54—8222	CROSS BODY BOX; FULL SIZE; DUAL, 0.105 DIAMOND PLATE LIDS; SMOOTH 0.112 ALUMINUM BODY; NOW INCLUDES MOUNTING KIT!; FIT: FORD SUPER DUTY 1999-2014	74	20	15

CROSS BODY TOOLBOXES

CROSS BODY BOXES — DUAL LID (Continued)		W"	D"	H"
54—8224	CROSS BODY BOX; FULL SIZE; DUAL, POLISHED 0.112 ALUMINUM LIDS; SMOOTH 0.112 ALUMINUM BODY; NOW INCLUDES MOUNTING KIT!; FIT: FORD SUPER DUTY 1999-2014	74	20	15
54—8252	CROSS BODY BOX; FULL SIZE; DUAL, 0.105 DIAMOND PLATE LIDS; SMOOTH 0.112 ALUMINUM BODY; NOW INCLUDES MOUNTING KIT!; FIT: DODGE DAKOTA, TOYOTA TACOMA 2005-2014, NISSAN FRONTIER	64	20	15
54—8254	CROSS BODY BOX; FULL SIZE; DUAL, POLISHED 0.112 ALUMINUM LIDS; SMOOTH 0.112 ALUMINUM BODY; NOW INCLUDES MOUNTING KIT!; FIT: DODGE DAKOTA, TOYOTA TACOMA 2005-2014, NISSAN FRONTIER	64	20	15
54—8272	CROSS BODY BOX; FULL SIZE; DUAL, 0.105 DIAMOND PLATE LIDS; SMOOTH 0.112 ALUMINUM BODY; NOW INCLUDES MOUNTING KIT!; FIT: TOYOTA T100, TOYOTA TUNDRA 1999-2006, NISSAN TITAN	67	20	15
54—8274	CROSS BODY BOX; FULL SIZE; DUAL, POLISHED 0.112 ALUMINUM LIDS; SMOOTH 0.112 ALUMINUM BODY; NOW INCLUDES MOUNTING KIT!; FIT: TOYOTA T100, TOYOTA TUNDRA 1999-2006, NISSAN TITAN	67	20	15
54—8277	CROSS BODY BOX; FULL SIZE; DUAL, POLISHED STAINLESS STEEL LIDS; SMOOTH 0.112 ALUMINUM BODY; NOW INCLUDES MOUNTING KIT!; FIT: TOYOTA T100	67	20	15
54—8292	CROSS BODY BOX; FULL SIZE; DUAL, 0.105 DIAMOND PLATE LIDS; SMOOTH 0.112 ALUMINUM BODY; NOW INCLUDES MOUNTING KIT!; FIT: DODGE 1500 5.5-FOOT BED 2009-2014	70	20	15
54—8294	CROSS BODY BOX; FULL SIZE; DUAL, POLISHED 0.112 ALUMINUM LIDS; SMOOTH 0.112 ALUMINUM BODY; NOW INCLUDES MOUNTING KIT!; FIT: DODGE 1500 5.5-FOOT BED 2009-2014	70	20	15
CROSS BODY BOXES — DUAL LID, EXTRA HEIGHT		W"	D"	H"
54—8012	CROSS BODY BOX; FULL SIZE; EXTRA HEIGHT; DUAL, 0.105 DIAMOND PLATE LIDS; SMOOTH 0.112 ALUMINUM BODY; NOW INCLUDES MOUNTING KIT!; FIT: CHEVY, DODGE, FORD F150, TOYOTA TUNDRA. [BOX IS 14" BELOW BED RAIL]	70	20	20.4
54—8014	CROSS BODY BOX; FULL SIZE; EXTRA HEIGHT; DUAL, POLISHED 0.112 ALUMINUM LID; SMOOTH 0.112 ALUMINUM BODY; NOW INCLUDES MOUNTING KIT!; FIT: CHEVY, DODGE, FORD F150, TOYOTA TUNDRA. [BOX IS 14" BELOW BED RAIL]	70	20	20.4

CROSS BODY BOXES — DUAL LID, EXTRA HEIGHT (Continued)		W"	D"	H"
54—8022	CROSS BODY BOX; FULL SIZE; EXTRA HEIGHT; DUAL, 0.105 DIAMOND PLATE LIDS; SMOOTH 0.112 ALUMINUM BODY; NOW INCLUDES MOUNTING KIT!; FIT: FORD SUPER DUTY 99+ [BOX IS 14" BELOW BED RAIL]	74	20	20.4
54—8024	CROSS BODY BOX; FULL SIZE; EXTRA HEIGHT; DUAL, POLISHED 0.112 ALUMINUM LIDS; SMOOTH 0.112 ALUMINUM BODY; NOW INCLUDES MOUNTING KIT!; FIT: FORD SUPER DUTY. [BOX IS 14" BELOW BED RAIL]	74	20	20.4
CROSS BODY BOXES — DUAL LID, EXTRA BREADTH		W"	D"	H"
54—8212—28	CROSS BODY BOX; FULL SIZE; EXTRA BREADTH; SINGLE, 0.105 DIAMOND PLATE LID; SMOOTH 0.112 ALUMINUM BODY; NOW INCLUDES MOUNTING KIT!; FIT: FULL SIZE CHEVY, DODGE, FORD 1973-1998, FORD F150, TOYOTA TUNDRA	70	28	15
54—8214—28	CROSS BODY BOX; FULL SIZE; EXTRA BREADTH; DUAL, POLISHED 0.112 ALUMINUM LIDS; SMOOTH 0.112 ALUMINUM BODY; NOW INCLUDES MOUNTING KIT!; FIT: FULL SIZE CHEVY, DODGE, FORD 1973-1998, FORD F150, TOYOTA TUNDRA	70	28	15
54—8222—28	CROSS BODY BOX; FULL SIZE; EXTRA BREADTH; DUAL, 0.105 DIAMOND PLATE LIDS; SMOOTH 0.112 ALUMINUM BODY; NOW INCLUDES MOUNTING KIT!; FIT: FORD SUPER DUTY	74	28	15
54—8224—28	CROSS BODY BOX; FULL SIZE; EXTRA BREADTH; DUAL, POLISHED 0.112 ALUMINUM LIDS; SMOOTH 0.112 ALUMINUM BODY; NOW INCLUDES MOUNTING KIT!; FIT: FORD SUPER DUTY 1999-2014	74	28	15
CROSS BODY BOXES — DUAL LID, EXTRA HEIGHT, EXTRA BREADTH		W"	D"	H"
54—8012—28	CROSS BODY BOX; FULL SIZE; EXTRA HEIGHT, EXTRA BREADTH; DUAL, 0.105 DIAMOND PLATE LIDS; SMOOTH 0.112 ALUMINUM BODY; NOW INCLUDES MOUNTING KIT!; FIT: CHEVY, DODGE, FORD F150, TOYOTA TUNDRA	70	28	20.4
54—8014—28	CROSS BODY BOX; FULL SIZE; EXTRA HEIGHT, EXTRA BREADTH; DUAL, POLISHED 0.112 ALUMINUM LID; SMOOTH 0.112 ALUMINUM BODY; NOW INCLUDES MOUNTING KIT!; FIT: CHEVY, DODGE, FORD F150, TOYOTA TUNDRA. [BOX IS 14" BELOW BED RAIL]	70	28	20.4
54—8022—28	CROSS BODY BOX; FULL SIZE; EXTRA HEIGHT, EXTRA BREADTH; DUAL, 0.105 DIAMOND PLATE LIDS; SMOOTH 0.112 ALUMINUM BODY; NOW INCLUDES MOUNTING KIT!; FIT: FORD SUPER DUTY	74	28	20.4

PICKUP TRUCK

CROSS BODY BOXES — DUAL LID, EXTRA HEIGHT, EXTRA BREADTH (Continued)		W"	D"	H"
54—8024—28	CROSS BODY BOX; FULL SIZE; EXTRA HEIGHT, EXTRA BREADTH; DUAL, POLISHED 0.112 ALUMINUM LIDS; SMOOTH 0.112 ALUMINUM BODY; NOW INCLUDES MOUNTING KIT!; FIT: FORD SUPER DUTY.	74	28	20.4
CROSS BODY BOXES FOR SMALL TRUCKS — DUAL LIDS		W"	D"	H"
54—8242	CROSS BODY BOX; DUAL, 0.105 DIAMOND PLATE LIDS; SMOOTH 0.112 ALUMINUM BODY; NOW INCLUDES MOUNTING KIT!; FIT: COMPACT, FORD RANGER, TOYOTA TACOMA 1995-2004	60	20	13.5
54—8244	CROSS BODY BOX; DUAL, POLISHED 0.112 ALUMINUM LIDS; SMOOTH 0.112 ALUMINUM BODY; NOW INCLUDES MOUNTING KIT!; FIT: COMPACT, FORD RANGER, TOYOTA TACOMA 1995-2004	60	20	13.5
54—8282	CROSS BODY BOX; FULL SIZE; DUAL, 0.105 DIAMOND PLATE LIDS; SMOOTH 0.112 ALUMINUM BODY; NOW INCLUDES MOUNTING KIT!; FIT: CHEVY COLORADO, GMC CANYON	62	20	13.5
54—8284	CROSS BODY BOX; FULL SIZE; DUAL, POLISHED 0.112 ALUMINUM LIDS; SMOOTH 0.112 ALUMINUM BODY; NOW INCLUDES MOUNTING KIT!; FIT: CHEVY COLORADO, GMC CANYON	62	20	13.5
CROSS BODY TOOLBOX TRAYS		W"	D"	H"
54—8200	TRAY 20" WIDE FOR PICKUP BOX	20		
54—8400	TRAY 24" WIDE FOR PICKUP BOX	24		
54—8208	TRAY 28" WIDE FOR PICKUP BOX	28		
54—8403	TRAY 30" WIDE FOR PICKUP BOX	30		
SIDE RAIL BOXES — PICKUP TRUCKS				
SIDE RAIL BOXES — STEEL DROP-DOWN DOOR		W"	D"	H"
54—6680—48	SIDE RAIL BOX; 14 GA MILD STEEL, BLACK POWDER PRIMER COATED; SINGLE DROP-DOWN DOOR; STAINLESS STEEL T-HANDLE LOCK	48	12	16
54—6680—72	SIDE RAIL BOX; 14 GA MILD STEEL, BLACK POWDER PRIMER COATED; DUAL DROP-DOWN DOORS; STAINLESS STEEL T-HANDLE LOCKS	72	12	16
54—6680—90	SIDE RAIL BOX; 14 GA MILD STEEL, BLACK POWDER PRIMER COATED; DUAL DROP-DOWN DOORS; STAINLESS STEEL T-HANDLE LOCKS	90	12	16
SIDE RAIL BOXES — ALUMINUM SINGLE, DROP-DOWN DOOR		W"	D"	H"
54—8680—48	SIDE RAIL BOX; SMOOTH 0.125 MILL FINISH ALUMINUM BODY; SINGLE, 0.105 DIAMOND PLATE ALUMINUM DROP-DOWN DOOR; STAINLESS STEEL T-HANDLE LOCKS	48	12	16

SIDE RAIL BOXES — ALUMINUM SINGLE, DROP-DOWN DOOR (Continued)		W"	D"	H"
54—8682—48	SIDE RAIL BOX; SMOOTH 0.125 MILL FINISH ALUMINUM BODY; SINGLE, POLISHED 0.112 ALUMINUM DROP-DOWN DOOR; STAINLESS STEEL T-HANDLE LOCKS	48	12	16
SIDE RAIL BOXES — ALUMINUM DUAL, DROP-DOWN DOORS		W"	D"	H"
54—8680—72	SIDE RAIL BOX; SMOOTH 0.125 MILL FINISH ALUMINUM BODY; DUAL, 0.105 DIAMOND PLATE ALUMINUM DROP-DOWN DOORS; STAINLESS STEEL T-HANDLE LOCKS	72	12	16
54—8680—90	SIDE RAIL BOX; SMOOTH 0.125 MILL FINISH ALUMINUM BODY; DUAL, 0.105 DIAMOND PLATE ALUMINUM DROP-DOWN DOORS; STAINLESS STEEL T-HANDLE LOCKS	90	12	16
54—8682—72	SIDE RAIL BOX; SMOOTH 0.125 MILL FINISH ALUMINUM BODY; DUAL, POLISHED 0.112 ALUMINUM DROP-DOWN DOORS; STAINLESS STEEL T-HANDLE LOCKS	72	12	16
54—8682—90	SIDE RAIL BOX; SMOOTH 0.125 MILL FINISH ALUMINUM BODY; DUAL, POLISHED 0.112 ALUMINUM DROP-DOWN DOORS; STAINLESS STEEL T-HANDLE LOCKS	90	12	16
SIDE RAIL BOXES — ALUMINUM, TOP-OPEN		W"	D"	H"
54—8620—36	SIDE RAIL BOX; SMOOTH 0.112 POLISHED ALUMINUM BODY; SINGLE, 0.105 DIAMOND PLATE ALUMINUM TOP-OPEN DOORS; STAINLESS STEEL T-HANDLE LOCKS	36	12	15
54—8620—48	SIDE RAIL BOX; SMOOTH 0.112 POLISHED ALUMINUM BODY; SINGLE, 0.105 DIAMOND PLATE ALUMINUM TOP-OPEN DOOR; STAINLESS STEEL T-HANDLE LOCKS	48	12	15
54—8620—60	SIDE RAIL BOX; SMOOTH 0.112 POLISHED ALUMINUM BODY; SINGLE, 0.105 DIAMOND PLATE ALUMINUM TOP-OPEN DOOR; STAINLESS STEEL T-HANDLE LOCKS	60	12	15
54—8620—72	SIDE RAIL BOX; SMOOTH 0.112 POLISHED ALUMINUM BODY; SINGLE, 0.105 DIAMOND PLATE ALUMINUM TOP-OPEN DOOR; STAINLESS STEEL T-HANDLE LOCKS	72	12	15
54—8620—90	SIDE RAIL BOX; SMOOTH 0.112 POLISHED ALUMINUM BODY; SINGLE, 0.105 DIAMOND PLATE ALUMINUM TOP-OPEN DOOR; STAINLESS STEEL T-HANDLE LOCKS	90	12	15
54—8626—36	SIDE RAIL BOX; SMOOTH 0.112 POLISHED ALUMINUM BODY; SINGLE, POLISHED 0.112 ALUMINUM TOP-OPEN DOOR; STAINLESS STEEL T-HANDLE LOCKS	36	12	15

CROSS BODY / IN-BED TOOLBOXES

SIDE RAIL BOXES — ALUMINUM, TOP-OPEN (Continued)		W"	D"	H"
54-8626-48	SIDE RAIL BOX; SMOOTH 0.112 POLISHED ALUMINUM BODY; SINGLE, POLISHED 0.112 ALUMINUM TOP-OPEN DOOR; STAINLESS STEEL T-HANDLE LOCKS	12	12	15
54-8626-60	SIDE RAIL BOX; SMOOTH 0.112 POLISHED ALUMINUM BODY; SINGLE, POLISHED 0.112 ALUMINUM TOP-OPEN DOOR; STAINLESS STEEL T-HANDLE LOCKS	12	12	15
54-8626-72	SIDE RAIL BOX; SMOOTH 0.112 POLISHED ALUMINUM BODY; SINGLE, POLISHED 0.112 ALUMINUM TOP-OPEN DOOR; STAINLESS STEEL T-HANDLE LOCKS	12	12	15
54-8626-90	SIDE RAIL BOX; SMOOTH 0.112 POLISHED ALUMINUM BODY; SINGLE, POLISHED 0.112 ALUMINUM TOP-OPEN DOOR; STAINLESS STEEL T-HANDLE LOCKS	12	12	15
54-8660-36	SIDE RAIL BOX; SMOOTH 0.112 POLISHED ALUMINUM BODY; SINGLE, 0.105 DIAMOND PLATE ALUMINUM TOP-OPEN DOOR; STAINLESS STEEL T-HANDLE LOCKS	36	16	15
54-8660-48	SIDE RAIL BOX; SMOOTH 0.112 POLISHED ALUMINUM BODY; SINGLE, 0.105 DIAMOND PLATE ALUMINUM TOP-OPEN DOOR; STAINLESS STEEL T-HANDLE LOCKS	48	16	15
54-8660-60	SIDE RAIL BOX; SMOOTH 0.112 POLISHED ALUMINUM BODY; SINGLE, 0.105 DIAMOND PLATE ALUMINUM TOP-OPEN DOOR; STAINLESS STEEL T-HANDLE LOCKS	60	16	15
54-8660-72	SIDE RAIL BOX; SMOOTH 0.112 POLISHED ALUMINUM BODY; SINGLE, 0.105 DIAMOND PLATE ALUMINUM TOP-OPEN DOOR; STAINLESS STEEL T-HANDLE LOCKS	72	16	15
54-8660-90	SIDE RAIL BOX; SMOOTH 0.112 POLISHED ALUMINUM BODY; SINGLE, 0.105 DIAMOND PLATE ALUMINUM TOP-OPEN DOOR; STAINLESS STEEL T-HANDLE LOCKS	90	16	15
54-8666-36	SIDE RAIL BOX; SMOOTH 0.112 POLISHED ALUMINUM BODY; SINGLE, POLISHED .112 POLISHED ALUMINUM TOP-OPEN DOOR; STAINLESS STEEL T-HANDLE LOCKS	36	16	15
54-8666-48	SIDE RAIL BOX; SMOOTH 0.112 POLISHED ALUMINUM BODY; SINGLE, POLISHED .112 POLISHED ALUMINUM TOP-OPEN DOOR; STAINLESS STEEL T-HANDLE LOCKS	48	16	15
54-8666-60	SIDE RAIL BOX; SMOOTH 0.112 POLISHED ALUMINUM BODY; SINGLE, POLISHED .112 POLISHED ALUMINUM TOP-OPEN DOOR; STAINLESS STEEL T-HANDLE LOCKS	60	16	15

SIDE RAIL BOXES — ALUMINUM, TOP-OPEN (Continued)		W"	D"	H"
54-8666-72	SIDE RAIL BOX; SMOOTH 0.112 POLISHED ALUMINUM BODY; SINGLE, POLISHED .112 POLISHED ALUMINUM TOP-OPEN DOOR; STAINLESS STEEL T-HANDLE LOCKS	72	16	15
54-8666-90	SIDE RAIL BOX; SMOOTH 0.112 POLISHED ALUMINUM BODY; SINGLE, POLISHED .112 POLISHED ALUMINUM TOP-OPEN DOOR; STAINLESS STEEL T-HANDLE LOCKS	90	16	15

RAIL BOX CONFIGURED OPTIONS — PICKUP TRUCKS

RAIL BOX TRAYS		W"	D"	H"
54-8600	TRAY FOR 12" WIDE RAIL BOX, SHIPPED LOOSE	14	12	
54-8606	TRAY FOR 16" WIDE RAIL BOX, SHIPPED LOOSE	14	16	
54-8600-36	TRAY FOR 12" WIDE RAIL BOX, 36" LG., INSTALLED	36	12	
54-8600-48	TRAY FOR 12" WIDE RAIL BOX, 48" LG., INSTALLED	48	12	
54-8600-60	TRAY FOR 12" WIDE RAIL BOX, 60" LG., INSTALLED	60	12	
54-8600-72	TRAY FOR 12" WIDE RAIL BOX, 72" LG., INSTALLED	72	12	
54-8600-90	TRAY FOR 12" WIDE RAIL BOX, 90" LG., INSTALLED	90	12	
54-8606-36	TRAY FOR 16" WIDE RAIL BOX, 36" LG., INSTALLED	36	16	
54-8606-48	TRAY FOR 16" WIDE RAIL BOX, 48" LG., INSTALLED	48	16	
54-8606-60	TRAY FOR 16" WIDE RAIL BOX, 60" LG., INSTALLED	60	16	
54-8606-72	TRAY FOR 16" WIDE RAIL BOX, 72" LG., INSTALLED	72	16	
54-8606-90	TRAY FOR 16" WIDE RAIL BOX, 90" LG., INSTALLED	90	16	

RAIL BOX MOUNTING BRACKETS		W"	D"	H"
54-8660-32	RAIL BOX MOUNTING BRACKETS (PAIR) 16" LONG	16		
54-8680-32	RAIL BOX MOUNTING BRACKETS (PAIR) 24" LONG	24		

IN-BED BOXES — PICKUP TRUCKS

IN-BED BOXES CHEST-STYLE		W"	D"	H"
54-8446	IN-BED BOX; CHEST-STYLE; SINGLE, POLISHED 0.112 ALUMINUM LID; POLISHED 0.112 ALUMINUM BODY; STAINLESS STEEL T-HANDLE LOCKS. MOUNTING KIT NOT INCLUDED; MOUNTING KIT NOT INCLUDED; FIT: CHEVY & DODGE LONG BEDS	60	24	19.4
54-8446-20	IN-BED BOX; CHEST-STYLE; SINGLE, POLISHED 0.112 ALUMINUM LID; POLISHED 0.112 ALUMINUM BODY; STAINLESS STEEL T-HANDLE LOCKS. MOUNTING KIT NOT INCLUDED; FIT: CHEVY & DODGE LONG BEDS	60	20	19.4

PICKUP TRUCK

IN-BED BOXES — PICKUP TRUCKS				
IN-BED BOXES CHEST-STYLE (Continued)		W"	D"	H"
54—8448	IN-BED BOX; CHEST-STYLE; SINGLE, STAINLESS STEEL LID; POLISHED 0.112 ALUMINUM BODY; STAINLESS STEEL T-HANDLE LOCKS. MOUNTING KIT NOT INCLUDED; FIT: CHEVY & DODGE LONG BEDS	60	24	19.4
54—8456	IN-BED BOX; CHEST-STYLE; SINGLE, POLISHED 0.112 ALUMINUM LID; POLISHED 0.112 ALUMINUM BODY; STAINLESS STEEL T-HANDLE LOCKS. MOUNTING KIT NOT INCLUDED; FIT: CHEVY 2007-2014 WITH A 5.5 FOOT SHORT BED	60	30	19.4
54—8458	IN-BED BOX; CHEST-STYLE; SINGLE, STAINLESS STEEL LID; POLISHED 0.112 ALUMINUM BODY; STAINLESS STEEL T-HANDLE LOCKS. MOUNTING KIT NOT INCLUDED; FIT: CHEVY 2007-2014 WITH A 5.5 FOOT SHORT BED	60	30	19.4
54—8463	IN-BED BOX; CHEST-STYLE; SINGLE, POLISHED 0.112 ALUMINUM LID; POLISHED 0.112 ALUMINUM BODY; STAINLESS STEEL T-HANDLE LOCKS; NO TRAY. MOUNTING KIT NOT INCLUDED; FIT: TACOMA, DAKOTA, FRONTIER CREW, RANGER STEP SIDE	38	20	17
54—8466	IN-BED BOX; CHEST-STYLE; SINGLE, POLISHED 0.112 ALUMINUM LID; POLISHED 0.112 ALUMINUM BODY; STAINLESS STEEL T-HANDLE LOCKS; NO TRAY. MOUNTING KIT NOT INCLUDED; FIT: COMPACT SIZE APPLICATIONS	47	20	19.4
54—8473	IN-BED BOX; CHEST-STYLE; SINGLE, POLISHED 0.112 ALUMINUM LID; POLISHED 0.112 ALUMINUM BODY; STAINLESS STEEL T-HANDLE LOCKS; NO TRAY. MOUNTING KIT NOT INCLUDED; FIT: CHEVY S10, FORD RANGER, DODGE DAKOTA	50.5	20	16.5
54—8476	IN-BED BOX; CHEST-STYLE; SINGLE, POLISHED 0.112 ALUMINUM LID; POLISHED 0.112 ALUMINUM BODY; STAINLESS STEEL T-HANDLE LOCKS; NO TRAY. MOUNTING KIT NOT INCLUDED; FIT: LOW PROFILE RV APPLICATIONS	60	20	10.5
IN-BED BOXES NOTCHED STYLE		W"	D"	H"
54—8420	IN-BED BOX; NOTCHED; SINGLE, 0.105 DIAMOND PLATE LID; POLISHED 0.112 ALUMINUM BODY; STAINLESS STEEL T-HANDLE LOCKS. MOUNTING KIT NOT INCLUDED; FIT: 6.5 FOOT SHORT BEDS; FORD 1973-1996, CHEVY 1988-2006, DODGE	60	24	19.4
54—8420—20	IN-BED BOX; NOTCHED; SINGLE, 0.105 DIAMOND PLATE LID; POLISHED 0.112 ALUMINUM BODY; STAINLESS STEEL T-HANDLE LOCKS. MOUNTING KIT NOT INCLUDED; FIT: 5.5 FOOT SHORT BEDS; CHEVY 2007-2014	60	20	20.5

IN-BED BOXES NOTCHED STYLE (Continued)		W"	D"	H"
54—8426	IN-BED BOX; NOTCHED; SINGLE, POLISHED 0.112 ALUMINUM LID; POLISHED 0.112 ALUMINUM BODY; STAINLESS STEEL T-HANDLE LOCKS. MOUNTING KIT NOT INCLUDED; FIT: 6.5 FOOT SHORT BEDS; CHEVY 2007-2014 FORD 1973-1996, CHEVY 1988-2006, DODGE	60	24	19.4
54—8426—20	IN-BED BOX; NOTCHED; SINGLE, POLISHED 0.112 ALUMINUM LID; POLISHED 0.112 ALUMINUM BODY; STAINLESS STEEL T-HANDLE LOCKS. MOUNTING KIT NOT INCLUDED; FIT: 5.5 FOOT SHORT BEDS; CHEVY 2007-2014	60	20	20.5
IN-BED BOXES V-NOTCHED		W"	D"	H"
54—8430	IN-BED BOX; V-NOTCHED; SINGLE, 0.105 DIAMOND PLATE ALUMINUM LID; POLISHED 0.112 ALUMINUM BODY; STAINLESS STEEL T-HANDLE LOCKS. MOUNTING KIT NOT INCLUDED; FIT: FORD F-150 SHORT OR LONG BEDS 1997-2003	60	24	19.4
54—8430—20	IN-BED BOX; V-NOTCHED; SINGLE, 0.105 DIAMOND PLATE ALUMINUM LID; POLISHED 0.112 ALUMINUM BODY; STAINLESS STEEL T-HANDLE LOCKS. MOUNTING KIT NOT INCLUDED; FIT: FORD F-150 2004-2014	60	20	21.5
54—8431	IN-BED BOX; V-NOTCHED; SINGLE, 0.105 DIAMOND PLATE ALUMINUM LID; POLISHED 0.112 ALUMINUM BODY; STAINLESS STEEL T-HANDLE LOCKS. FIT 8-FOOT BEDS; FORD F-150 2004-2014 AND TOYOTA TUNDRA 2007-2014	60	20	21.5
54—8431—20	IN-BED BOX; V-NOTCHED; SINGLE, 0.105 DIAMOND PLATE ALUMINUM LID; POLISHED 0.112 ALUMINUM BODY; STAINLESS STEEL T-HANDLE LOCKS. FIT 6.5 FOOT BEDS; FORD F-150 2004-2014 AND TOYOTA TUNDRA 2007-2014	60	20	21.5
54—8440	IN-BED BOX; V-NOTCHED; SINGLE, 0.105 DIAMOND PLATE ALUMINUM LID; POLISHED 0.112 ALUMINUM BODY; STAINLESS STEEL T-HANDLE LOCKS. MOUNTING KIT NOT INCLUDED; FIT: CHEVY & DODGE LONG BEDS	60	24	19.4
54—8440—20	IN-BED BOX; V-NOTCHED; SINGLE, 0.105 DIAMOND PLATE ALUMINUM LID; POLISHED 0.112 ALUMINUM BODY; STAINLESS STEEL T-HANDLE LOCKS. MOUNTING KIT NOT INCLUDED; FIT: CHEVY & DODGE LONG BEDS	60	20	19.4
54—8441	IN-BED BOX; V-NOTCHED; SINGLE, 0.105 DIAMOND PLATE ALUMINUM LID; POLISHED 0.112 ALUMINUM BODY; STAINLESS STEEL T-HANDLE LOCKS. MOUNTING KIT NOT INCLUDED; FIT: CHEVY 2007-2014 WITH 6-1/2 FOOT & 8 FOOT BEDS	60	24	20.5

IN-BED / SIDE RAIL TOOLBOXES

IN-BED BOXES V-NOTCHED (Continued)		W"	D"	H"
54-8450	IN-BED BOX; V-NOTCHED; SINGLE, 0.105 DIAMOND PLATE ALUMINUM LID; POLISHED 0.112 ALUMINUM BODY; STAINLESS STEEL T-HANDLE LOCKS. MOUNTING KIT NOT INCLUDED; FIT: FORD 1973-1996, CHEVY 1988-2006, DODGE WITH 6.5 FOOT SHORT BEDS	60	30	19.4
54-8460	IN-BED BOX; V-NOTCHED; SINGLE, 0.105 DIAMOND PLATE ALUMINUM LID; POLISHED 0.112 ALUMINUM BODY; STAINLESS STEEL T-HANDLE LOCKS; NO TRAY. MOUNTING KIT NOT INCLUDED; FIT: COMPACT SIZE APPLICATIONS	47	20	19.4
54-8461	IN-BED BOX; V-NOTCHED; SINGLE, 0.105 DIAMOND PLATE ALUMINUM LID; POLISHED 0.112 ALUMINUM BODY; STAINLESS STEEL T-HANDLE LOCKS; NO TRAY. MOUNTING KIT NOT INCLUDED; FIT: TACOMA, DAKOTA, FRONTIER CREW, RANGER STEP SIDE	38	20	17
54-8470	IN-BED BOX; V-NOTCHED; SINGLE, 0.105 DIAMOND PLATE ALUMINUM LID; POLISHED 0.112 ALUMINUM BODY; STAINLESS STEEL T-HANDLE LOCKS; NO TRAY. MOUNTING KIT NOT INCLUDED; FIT: LOW PROFILE RV APPLICATIONS	60	20	10.5
54-8471	IN-BED BOX; V-NOTCHED; SINGLE, 0.105 DIAMOND PLATE ALUMINUM LID; POLISHED 0.112 ALUMINUM BODY; STAINLESS STEEL T-HANDLE LOCKS; NO TRAY. MOUNTING KIT NOT INCLUDED; FIT: CHEVY S10, FORD RANGER, DODGE DAKOTA	50.5	20	16.5
54-8480	IN-BED BOX; V-NOTCHED; SINGLE, 0.105 DIAMOND PLATE ALUMINUM LID; POLISHED 0.112 ALUMINUM BODY; STAINLESS STEEL T-HANDLE LOCKS. MOUNTING KIT NOT INCLUDED; FIT: FORD SUPER DUTY 1999-2014 LONG BED	63	24	19.4
54-8480-30	IN-BED BOX; V-NOTCHED; SINGLE, 0.105 DIAMOND PLATE ALUMINUM LID; POLISHED, 0.112 ALUMINUM BODY; STAINLESS STEEL T-HANDLE LOCKS. MOUNTING KIT NOT INCLUDED; FIT: FORD SUPER DUTY 1999-2014 LONG BED	63	30	19.4
54-8490	IN-BED BOX; V-NOTCHED; SINGLE, 0.105 DIAMOND PLATE ALUMINUM LID; POLISHED 0.112 ALUMINUM BODY; STAINLESS STEEL T-HANDLE LOCKS. MOUNTING KIT NOT INCLUDED; FIT: FORD SUPER DUTY 1999-2014 SHORT BED	63	24	19.4
54-8433	IN-BED BOX; V-NOTCHED; SINGLE, POLISHED 0.112 ALUMINUM LID; POLISHED 0.112 ALUMINUM BODY; STAINLESS STEEL T-HANDLE LOCKS. FIT 8-FOOT BEDS: FORD F-150 2004-2014 AND TOYOTA TUNDRA 2007-2014	60	24	21.5

IN-BED BOXES V-NOTCHED (Continued)		W"	D"	H"
54-8433-20	IN-BED BOX; V-NOTCHED; SINGLE, POLISHED 0.112 ALUMINUM LID; POLISHED 0.112 ALUMINUM BODY; STAINLESS STEEL T-HANDLE LOCKS. FIT 6.5 FOOT BEDS: FORD F-150 2004-2014 AND TOYOTA TUNDRA 2007-2014	60	20	21.5
54-8436	IN-BED BOX; V-NOTCHED; SINGLE, POLISHED 0.112 ALUMINUM LID; POLISHED 0.112 ALUMINUM BODY; STAINLESS STEEL T-HANDLE LOCKS. MOUNTING KIT NOT INCLUDED; FIT: FORD F-150 SHORT OR LONG BEDS 1997-2003	60	24	19.4
54-8436-20	IN-BED BOX; V-NOTCHED; SINGLE, POLISHED 0.112 ALUMINUM LID; POLISHED 0.112 ALUMINUM BODY; STAINLESS STEEL T-HANDLE LOCKS. MOUNTING KIT NOT INCLUDED; FIT: FORD F-150 2004-2014	60	20	21.5
54-8496	IN-BED BOX; V-NOTCHED; SINGLE, POLISHED 0.112 ALUMINUM LID; POLISHED 0.112 ALUMINUM BODY; STAINLESS STEEL T-HANDLE LOCKS. MOUNTING KIT NOT INCLUDED; FIT: FORD SUPER DUTY 1999-2014 SHORT BED	63	24	19.4
54-8486	IN-BED BOX; V-NOTCHED; SINGLE, POLISHED 0.112 ALUMINUM LID; POLISHED 0.112 ALUMINUM BODY; STAINLESS STEEL T-HANDLE LOCKS. MOUNTING KIT NOT INCLUDED; FIT: FORD SUPER DUTY 1999-2014 LONG BED	63	24	19.4
54-8486-30	IN-BED BOX; V-NOTCHED; SINGLE, POLISHED 0.112 ALUMINUM LID; POLISHED 0.112 ALUMINUM BODY; STAINLESS STEEL T-HANDLE LOCKS. MOUNTING KIT NOT INCLUDED; FIT: FORD SUPER DUTY LONG BED	63	30	19.4
54-8443	IN-BED BOX; V-NOTCHED; SINGLE, POLISHED 0.112 ALUMINUM LID; POLISHED 0.112 ALUMINUM BODY; STAINLESS STEEL T-HANDLE LOCKS. MOUNTING KIT NOT INCLUDED; FIT: CHEVY 2007-2014 WITH 6.5 FOOT AND 8 FOOT BEDS	60	24	20.5

WHEEL WELL BOXES — PICKUP TRUCKS

WHEEL WELL BOXES		W"	D"	H"
54-7545L	WHEEL WELL BOX; SINGLE, 0.105 DIAMOND PLATE ALUMINUM LID; 0.125 MILL FINISH ALUMINUM BODY. DRIVER-SIDE FIT: FULL SIZE PICKUPS	45	9	19
54-7545R	WHEEL WELL BOX; SINGLE, 0.105 DIAMOND PLATE ALUMINUM LID; 0.125 MILL FINISH ALUMINUM BODY. PASSENGER-SIDE FIT: FULL SIZE PICKUPS	45	9	19
54-7545S-L	WHEEL WELL BOX; SINGLE, POLISHED 0.112 ALUMINUM LID; 0.125 MILL FINISH ALUMINUM BODY. DRIVER-SIDE FIT: FULL SIZE PICKUPS	45	9	19
54-7545S-R	WHEEL WELL BOX; SINGLE, POLISHED 0.112 ALUMINUM LID; 0.125 MILL FINISH ALUMINUM BODY. PASSENGER-SIDE FIT: FULL SIZE PICKUPS	45	9	19

PICKUP TRUCK IN-BED / SIDE RAIL TOOLBOXES

CONTRACTOR BOXES — PICKUP TRUCKS				
CONTRACTOR BOXES		W"	D"	H"
54—7840	CONTRACTOR BOX; SINGLE, 0.105 DIAMOND PLATE ALUMINUM LID; SINGLE, 0.105 DIAMOND PLATE ALUMINUM DROP-DOWN DOOR; 0.125 MILL FINISH ALUMINUM BODY; INCLUDES 6.5" DIVIDERS IN TOP COMPARTMENT AND STAINLESS STEEL T-HANDLE LOCKS.	48	18	20
54—7850	CONTRACTOR BOX; SINGLE, 0.105 DIAMOND PLATE ALUMINUM LID; SINGLE, 0.105 DIAMOND PLATE ALUMINUM DROP-DOWN DOOR; 0.125 MILL FINISH ALUMINUM BODY; INCLUDES 6.5" DIVIDERS IN TOP COMPARTMENT AND STAINLESS STEEL T-HANDLE LOCKS.	60	18	20
54—7860	CONTRACTOR BOX; SINGLE, 0.105 DIAMOND PLATE ALUMINUM LID; DUAL, 0.105 DIAMOND PLATE ALUMINUM DROP-DOWN DOORS; 0.125 MILL FINISH ALUMINUM BODY; INCLUDES 6.5" DIVIDERS IN TOP COMPARTMENT AND STAINLESS STEEL T-HANDLE LOCKS.	72	18	20
54—7870	CONTRACTOR BOX; SINGLE, 0.105 DIAMOND PLATE ALUMINUM LID; DUAL, 0.105 DIAMOND PLATE ALUMINUM DROP-DOWN DOORS; 0.125 MILL FINISH ALUMINUM BODY; INCLUDES 6.5" DIVIDERS IN TOP COMPARTMENT AND STAINLESS STEEL T-HANDLE LOCKS.	84	18	20
54—7880	CONTRACTOR BOX; SINGLE, 0.105 DIAMOND PLATE ALUMINUM LID; DUAL, 0.105 DIAMOND PLATE ALUMINUM DROP-DOWN DOORS; 0.125 MILL FINISH ALUMINUM BODY; INCLUDES 6.5" DIVIDERS IN TOP COMPARTMENT AND STAINLESS STEEL T-HANDLE LOCKS.	96	18	20
54—7846	CONTRACTOR BOX; SINGLE, POLISHED 0.112 ALUMINUM LID; SINGLE, POLISHED 0.112 ALUMINUM LID DROP-DOWN DOOR; 0.125 MILL FINISH ALUMINUM BODY; INCLUDES 6.5" DIVIDERS IN TOP COMPARTMENT AND STAINLESS STEEL T-HANDLE LOCKS.	48	18	20
54—7856	CONTRACTOR BOX; SINGLE, POLISHED 0.112 ALUMINUM LID; SINGLE, POLISHED 0.112 ALUMINUM LID DROP-DOWN DOOR; 0.125 MILL FINISH ALUMINUM BODY; INCLUDES 6.5" DIVIDERS IN TOP COMPARTMENT AND STAINLESS STEEL T-HANDLE LOCKS.	60	18	20

CONTRACTOR BOXES (Continued)				
		W"	D"	H"
54—7866	CONTRACTOR BOX; SINGLE, POLISHED 0.112 ALUMINUM LID; DUAL, POLISHED 0.112 ALUMINUM LID DROP-DOWN DOORS; 0.125 MILL FINISH ALUMINUM BODY; INCLUDES 6.5" DIVIDERS IN TOP COMPARTMENT AND STAINLESS STEEL T-HANDLE LOCKS.	72	18	20
54—7876	CONTRACTOR BOX; SINGLE, POLISHED 0.112 ALUMINUM LID; DUAL, POLISHED 0.112 ALUMINUM LID DROP-DOWN DOORS; 0.125 MILL FINISH ALUMINUM BODY; INCLUDES 6.5" DIVIDERS IN TOP COMPARTMENT AND STAINLESS STEEL T-HANDLE LOCKS.	84	18	20
54—7886	CONTRACTOR BOX; SINGLE, POLISHED 0.112 ALUMINUM LID; DUAL, POLISHED 0.112 ALUMINUM LID DROP-DOWN DOORS; 0.125 MILL FINISH ALUMINUM BODY; INCLUDES 6.5" DIVIDERS IN TOP COMPARTMENT AND STAINLESS STEEL T-HANDLE LOCKS.	96	18	20

TRAILER TONGUE TOOLBOXES				
TRAILER TONGUE WEDGE-SHAPE TOOLBOXES		W"	D"	H"
54—7212	TONGUE BOX; WEDGE-SHAPE; SINGLE-PANEL 0.105 DIAMOND PLATE FRONT AND SIDES WITH 0.125 MILL FINISH ALUMINUM BACK AND BOTTOM; LOCKING T-HANDLE; 0.105 DIAMOND PLATE LID; GAS SHOCK; 18.18-INCH WIDE FRONT.	30	12	24
54—7218	TONGUE BOX; WEDGE-SHAPE; SINGLE-PANEL 0.105 DIAMOND PLATE FRONT AND SIDES WITH 0.125 MILL FINISH ALUMINUM BACK AND BOTTOM; LOCKING T-HANDLE; 0.105 DIAMOND PLATE LID; GAS SHOCK; 13.18-INCH W FRONT.	30	18	24
54—7224	TONGUE BOX; WEDGE-SHAPE; SINGLE-PANEL 0.105 DIAMOND PLATE FRONT AND SIDES WITH 0.125 MILL FINISH ALUMINUM BACK AND BOTTOM; LOCKING T-HANDLE; 0.105 DIAMOND PLATE LID; 7.63-INCH WIDE FRONT.	30	24	24



PICKUP CAB RACKS

PROTECH PICKUP CAB RACKS.

Designed for work. Built to last.

FEATURES

RACKS FIT FLUSH WITH TRUCK BOX



SHOWN WITH AMPLIMESH WINDOW



MITERED TUBES

Tubes are mitered then joined with TIG welds that are hand cleaned and buffed

Standard cab rack leg length is 24", with 32" length available for flush fitting of transfer tanks



PROPRIETARY HEPTAGONAL FORMED TUBE STRUCTURE

With no bends, delivers the equivalent deflection strength of steel with significant weight savings and durability. That alone eliminates a lot of headaches.

STANDARD MATERIALS AND FINISHES

PANELS

- Amplimesh® 6063-T4 aluminum
- Diamond plate 0.105" marine-grade 5052 aluminum
- Louvers 0.112" marine-grade 6061 aluminum

TUBES

Marine-Grade 0.125" thick wall, 6061 tubes, welded to foot panels.

STANDARD COLORS

NATURAL



NATURAL

POWDER COAT



BLACK

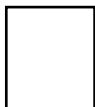

WHITE



ROUND TUBE WINDOW OPTION

Horizontal tubes are 1" schedule 40, 5052 aluminum pipe.

PROTECH LOW PROFILE CROSS BODY TOOLBOX

Configured Options cab rack with extended feet, vertical stops, LED lighting and open center window with Amplimesh side panels.



PICKUP CAB RACKS

PICKUP RACKS

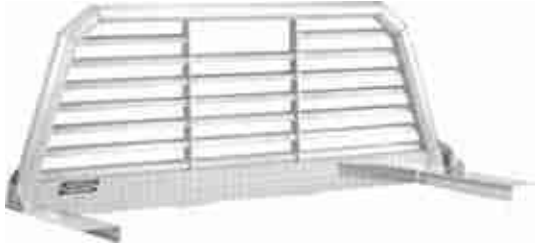

LOUVERS AND DIAMOND PLATE

SHOWN: 57-6839-24



AMPLIMESH WITH DIAMOND PLATE

SHOWN: 54-6440-24



LUMBER/CARGO RACK

SHOWN: 50-6445

Rear hoop includes welded
4" vertical lumber stops
as standard

ProTech pickup truck cab racks are the robust, light truck version of the cab racks that you see on the heavy duty, class-8 rigs on highways across the country — or the off-road logging trucks in the Northwest. We weld panels flush to our own heptagonal tube design, to give you a strong, integrated structure with multiple tie-down possibilities. And durable, long-life performance.

PICKUP CAB RACKS NOW FOUR WAYS:

- With Amplimesh window and diamond plate
- With Louver window and diamond plate
- With round aluminum tube window and diamond plate
- Open center window cutout and diamond plate panel

ACCESSORIZE YOUR CAB RACK ORDER

- Light brackets
- Beacon light plates
- Load light brackets
- Antenna brackets
- Framed cutouts for load lights
- Slider window cutout for louvered rack
- Slider window cutout for Amplimesh rack
- Vertical lumber stops — 4" height
- Flag holders
- Rope hook
- Rope loop
- Rope cleat
- Oversize load sign sockets
- Oversize load sign bars
- Oversize load sign socket/bar hardware assembly
- Wooden oversize load sign, with socket/bar hardware assembly
- Round tube cab rack
- Cab rack feet the full length of your truck bed

SEE PAGE 57 FOR CAB RACK OPTIONS



RAFTER 9X RANCH

ProTech Pickup Cab Rack — Amplimesh

PICKUP TRUCK CAB RACK FITMENT GUIDE

PICKUP TRUCK CAB RACK FITMENT GUIDE

CAB RACK SELECTION			REAR CARGO RACK PART NUMBER
Mesh	Part Number	Part Number	

CHEVROLET & GMC		CAB RACK SELECTION			REAR CARGO RACK PART NUMBER
		Mesh	No Mesh	Louvered	
SILVERADO/SIERRA (FULL SIZE)					
2015 - 2017	8', 6 1/2' and 5 1/2' Box	57-6450	57-6457	57-6459	50-6455
2007 - 2014	8', 6 1/2' and 5 1/2' Box	57-6440	57-6447	57-6449	50-6445
1999 - 2006	8' Box and 6 1/2' Box	57-6430	57-6437	57-6439	50-6435
	5 1/2' Box	Custom	Custom	Custom	Custom
1988 - 1998	8' Box; 6 1/2' Box	57-6240	57-6247	57-6249	50-6245
COLORADO/CANYON					
2015 - 2017	Crew Cab; Extended Cab	57-62150	57-62157	57-62159	Custom
2004 - 2014	Crew Cab; Extended Cab	57-6230	57-6237	57-6239	Custom
S10/S15/SONOMA (EXCLUDING STEP SIDE)					
1985 - 2003	All (Except Step Side)	57-6220	57-6227	57-6229	Custom
FORD					
F250/F350					
2017	8' Box; 6 1/2' Box	57-6840	57-6847	57-6849	Custom
2008 - 2016	8' Box; 6 1/2' Box	57-6830	57-6837	57-6839	50-6845
1999 - 2007	8' Box; 6 1/2' Box	57-6830	57-6837	57-6839	50-6835
1973 - 1998	8' Box; 6 1/2' Box	57-6530	57-6537	57-6539	50-6535
F150 (EXCLUDING STEP SIDE)					
2004 - 2017	8' Box; 6 1/2' Box	57-6870	57-6877	57-6879	50-6875
	5 1/2' Box	57-6870	57-6877	57-6879	Custom
1997 - 2003	8' Box; 6 1/2' Box	57-6860	57-6867	57-6869	50-6865
	5 1/2' Box	57-6860	57-6867	57-6869	Custom
1973 - 1996	8' Box; 6 1/2' Box	57-6370	57-6377	57-6379	50-6535
RANGER (EXCLUDING STEP SIDE)					
1993 - 2011	All (Except Step Side)	57-6520	57-6527	57-6529	Custom
DODGE & RAM					
2500/3500					
2017	8' Box; 6 1/2' Box	57-6370	57-6377	57-6379	Custom
2010-2016	8' Box; 6 1/2' Box	57-6370	57-6377	57-6379	50-6365
2003 - 2009	8' Box; 6 1/2' Box	57-6350	57-6357	57-6359	50-6355
1973 - 2002	8' Box; 6 1/2' Box	57-6340	57-6347	57-6349	50-6345
1500					
2009-2016	8' Box; 6 1/2' Box	57-6370	57-6377	57-6379	50-6365
	5 1/2' Box	57-6360	57-6367	57-6369	50-6365
	5 1/2' Box w/Ram Box	n/a	n/a	n/a	n/a
2002 - 2008	8' Box; 6 1/2' Box	57-6350	57-6357	57-6359	50-6355
1973 - 2001	8' Box; 6 1/2' Box	57-6340	57-6347	57-6349	50-6345
DAKOTA					
1985 - 2011	All	57-6320	57-6327	57-6329	Custom
NISSAN					
TITAN					
2004 - 2014	All	57-6730	57-6737	57-6739	Custom
FRONTIER					
2004 - 2014	All	57-6740	57-6747	57-6749	Custom
1998 - 2003	All	57-6720	57-6727	57-6729	Custom
TOYOTA					
TUNDRA (EXCLUDING STEP SIDE)					
2014 - 2016	8' Box; 6 1/2' Box	57-6960	57-6967	57-6969	50-6965
	5 1/2' Box	57-6960	57-6967	57-6969	Custom
2007 - 2013	8' Box; 6 1/2' Box	57-6950	57-6957	57-6959	50-6955
	6 1/2' Box	57-6950	57-6957	57-6959	50-6955
1993 - 2006	All	57-6940	57-6947	57-6949	50-6945
TACOMA/PICKUP (EXCLUDING STEP SIDE)					
2005 - 2014	All	57-6930	57-6937	57-6939	Custom
1995 - 2004	All	57-6920	57-6927	57-6929	Custom

PICKUP TRUCK

PICKUP TRUCK CAB RACKS — 24-INCH LEGS	
57-6220-24	PICKUP CAB RACKS; CHEVY S-10; HEPT-TUBE STRUCTURE; WITH AMPLIMESH AND DIAMOND PLATE; 24-INCH LEGS
57-6227-24	PICKUP CAB RACKS; CHEVY S-10; HEPT-TUBE STRUCTURE; WITHOUT AMPLIMESH; 24-INCH LEGS
57-6229-24	PICKUP CAB RACKS; CHEVY S-10; HEPT-TUBE STRUCTURE; WITH LOUVERS AND DIAMOND PLATE; 24-INCH LEGS
57-6230-24	PICKUP CAB RACKS; CHEVY COLORADO / GMC CANYON; HEPT-TUBE STRUCTURE; WITH AMPLIMESH AND DIAMOND PLATE; 24-INCH LEGS
57-6237-24	PICKUP CAB RACKS; CHEVY COLORADO / GMC CANYON; HEPT-TUBE STRUCTURE; WITHOUT AMPLIMESH; 24-INCH LEGS
57-6239-24	PICKUP CAB RACKS; CHEVY COLORADO / GMC CANYON; HEPT-TUBE STRUCTURE; WITH LOUVERS AND DIAMOND PLATE; 24-INCH LEGS
57-6240-24	PICKUP CAB RACKS; CHEVY FULL-SIZE 1988-1998; HEPT-TUBE STRUCTURE; WITH AMPLIMESH AND DIAMOND PLATE; 24-INCH LEGS
57-6247-24	PICKUP CAB RACKS; CHEVY FULL-SIZE 1988-1998; HEPT-TUBE STRUCTURE; WITHOUT AMPLIMESH; 24-INCH LEGS
57-6249-24	PICKUP CAB RACKS; CHEVY FULL-SIZE 1988-1998; HEPT-TUBE STRUCTURE; WITH LOUVERS AND DIAMOND PLATE; 24-INCH LEGS
57-6320-24	PICKUP CAB RACKS; DODGE DAKOTA; HEPT-TUBE STRUCTURE; WITH AMPLIMESH AND DIAMOND PLATE; 24-INCH LEGS
57-6327-24	PICKUP CAB RACKS; DODGE DAKOTA; HEPT-TUBE STRUCTURE; WITHOUT AMPLIMESH; 24-INCH LEGS
57-6329-24	PICKUP CAB RACKS; DODGE DAKOTA; HEPT-TUBE STRUCTURE; WITH LOUVERS AND DIAMOND PLATE; 24-INCH LEGS
57-6340-24	PICKUP CAB RACKS; DODGE FULL-SIZE 1973-2002, DODGE 1500 1973-2001; HEPT-TUBE STRUCTURE; WITH AMPLIMESH AND DIAMOND PLATE; 24-INCH LEGS
57-6347-24	PICKUP CAB RACKS; DODGE FULL-SIZE 1973-2002, DODGE 1500 1973-2001; HEPT-TUBE STRUCTURE; WITHOUT AMPLIMESH; 24-INCH LEGS
57-6349-24	PICKUP CAB RACKS; DODGE FULL-SIZE 1973-2002, DODGE 1500 1973-2001; HEPT-TUBE STRUCTURE; WITH LOUVERS AND DIAMOND PLATE; 24-INCH LEGS
57-6350-24	PICKUP CAB RACKS; DODGE FULL-SIZE 2003-2009, DODGE 1500 2002-2008; HEPT-TUBE STRUCTURE; WITH AMPLIMESH AND DIAMOND PLATE; 24-INCH LEGS
57-6357-24	PICKUP CAB RACKS; DODGE FULL-SIZE 2003-2009, DODGE 1500 2002-2008; HEPT-TUBE STRUCTURE; WITHOUT AMPLIMESH; 24-INCH LEGS
57-6359-24	PICKUP CAB RACKS; DODGE FULL-SIZE 2003-2009, DODGE 1500 2002-2008; HEPT-TUBE STRUCTURE; WITH LOUVERS AND DIAMOND PLATE; 24-INCH LEGS
57-6360-24	PICKUP CAB RACKS; DODGE 1500 5 1/2' BOX- 2009-2014; HEPT-TUBE STRUCTURE; WITH AMPLIMESH AND DIAMOND PLATE; 24-INCH LEGS
57-6367-24	PICKUP CAB RACKS; DODGE 1500 5 1/2' BOX- 2009-2014; HEPT-TUBE STRUCTURE; WITHOUT AMPLIMESH; 24-INCH LEGS
57-6369-24	PICKUP CAB RACKS; DODGE 1500 5 1/2' BOX- 2009-2014; HEPT-TUBE STRUCTURE; WITH LOUVERS AND DIAMOND PLATE; 24-INCH LEGS
57-6370-24	PICKUP CAB RACKS; DODGE 2500 2010-2014, FORD F150 1973-1996, DODGE 1500 6 1/2' AND 8 1/2' BOX 2009-2014; HEPT-TUBE STRUCTURE; WITH AMPLIMESH AND DIAMOND PLATE; 24-INCH LEGS
57-6377-24	PICKUP CAB RACKS; DODGE 2500 2010-2014, FORD F150 1973-1996, DODGE 1500 6 1/2' AND 8 1/2' BOX 2009-2014; HEPT-TUBE STRUCTURE; WITHOUT AMPLIMESH; 24-INCH LEGS

PICKUP TRUCK CAB RACKS — 24-INCH LEGS (Continued)	
57-6379-24	PICKUP CAB RACKS; DODGE 2500 2010-2014, FORD F150 1973-1996, DODGE 1500 6 1/2' AND 8 1/2' BOX 2009-2014; HEPT-TUBE STRUCTURE; WITH LOUVERS AND DIAMOND PLATE; 24-INCH LEGS
57-6430-24	PICKUP CAB RACKS; CHEVY SILVERADO 1999-2006; HEPT-TUBE STRUCTURE; WITH AMPLIMESH AND DIAMOND PLATE; 24-INCH LEGS
57-6437-24	PICKUP CAB RACKS; CHEVY SILVERADO 1999-2006; HEPT-TUBE STRUCTURE; WITHOUT AMPLIMESH; 24-INCH LEGS
57-6439-24	PICKUP CAB RACKS; CHEVY SILVERADO 1999-2006; HEPT-TUBE STRUCTURE; WITH LOUVERS AND DIAMOND PLATE; 24-INCH LEGS
57-6440-24	PICKUP CAB RACKS; CHEVY SILVERADO 2007-2014; HEPT-TUBE STRUCTURE; WITH AMPLIMESH AND DIAMOND PLATE; 24-INCH LEGS
57-6447-24	PICKUP CAB RACKS; CHEVY SILVERADO 2007-2014; HEPT-TUBE STRUCTURE; WITHOUT AMPLIMESH; 24-INCH LEGS
57-6449-24	PICKUP CAB RACKS; CHEVY SILVERADO 2007-2014; HEPT-TUBE STRUCTURE; WITH LOUVERS AND DIAMOND PLATE; 24-INCH LEGS
57-6450-24	PICKUP CAB RACKS; CHEVY SILVERADO 2015+ ; WITH AMPLIMESH AND DIAMOND PLATE; 24-INCH LEGS
57-6457-24	PICKUP CAB RACKS; CHEVY SILVERADO 2015+ ; WITHOUT AMPLIMESH; 24-INCH LEGS
57-6459-24	PICKUP CAB RACKS; CHEVY SILVERADO 2015+ ; WITH LOUVERS AND DIAMOND PLATE; 24-INCH LEGS
57-6520-24	PICKUP CAB RACKS; FORD RANGER; HEPT-TUBE STRUCTURE; WITH AMPLIMESH AND DIAMOND PLATE; 24-INCH LEGS
57-6527-24	PICKUP CAB RACKS; FORD RANGER; HEPT-TUBE STRUCTURE; WITHOUT AMPLIMESH; 24-INCH LEGS
57-6529-24	PICKUP CAB RACKS; FORD RANGER; HEPT-TUBE STRUCTURE; WITH LOUVERS AND DIAMOND PLATE; 24-INCH LEGS
57-6530-24	PICKUP CAB RACKS; F250 / F350 1973-1997; HEPT-TUBE STRUCTURE; WITH AMPLIMESH AND DIAMOND PLATE; 24-INCH LEGS
57-6537-24	PICKUP CAB RACKS; F250 / F350 1973-1997; HEPT-TUBE STRUCTURE; WITHOUT AMPLIMESH; 24-INCH LEGS
57-6539-24	PICKUP CAB RACKS; F250 / F350 1973-1997; HEPT-TUBE STRUCTURE; WITH LOUVERS AND DIAMOND PLATE; 24-INCH LEGS
57-6720-24	PICKUP CAB RACKS -NISSAN FRONTIER 1998-2003; HEPT-TUBE STRUCTURE; WITH AMPLIMESH AND DIAMOND PLATE; 24-INCH LEGS
57-6727-24	PICKUP CAB RACKS; NISSAN FRONTIER 1998-2003; HEPT-TUBE STRUCTURE; WITHOUT AMPLIMESH; 24-INCH LEGS
57-6729-24	PICKUP CAB RACKS; NISSAN FRONTIER 1998-2003; HEPT-TUBE STRUCTURE; WITH LOUVERS AND DIAMOND PLATE; 24-INCH LEGS
57-6730-24	PICKUP CAB RACKS; NISSAN TITAN; HEPT-TUBE STRUCTURE; WITH AMPLIMESH AND DIAMOND PLATE; 24-INCH LEGS
57-6737-24	PICKUP CAB RACKS; NISSAN TITAN; HEPT-TUBE STRUCTURE; WITHOUT AMPLIMESH; 24-INCH LEGS
57-6739-24	PICKUP CAB RACKS; NISSAN TITAN; HEPT-TUBE STRUCTURE; WITH LOUVERS AND DIAMOND PLATE; 24-INCH LEGS
57-6740-24	PICKUP CAB RACK; NISSAN FRONTIER 2004-2014; HEPT-TUBE STRUCTURE; WITH AMPLIMESH AND DIAMOND PLATE; 24-INCH LEGS
57-6747-24	PICKUP CAB RACK; NISSAN FRONTIER 2004-2014; HEPT-TUBE STRUCTURE; WITHOUT AMPLIMESH; 24-INCH LEGS

PICKUP TRUCK CAB RACKS

PICKUP TRUCK CAB RACKS — 24-INCH LEGS (Continued)	
57-6749-24	PICKUP CAB RACK; NISSAN FRONTIER 2004-2014; HEPT-TUBE STRUCTURE; WITH LOUVERS AND DIAMOND PLATE; 24-INCH LEGS
57-6830-24	PICKUP CAB RACKS; FORD SUPER DUTY 1999-2014; HEPT-TUBE STRUCTURE; WITH AMPLIMESH AND DIAMOND PLATE; 24-INCH LEGS
57-6837-24	PICKUP CAB RACKS; FORD SUPER DUTY 1999-2014; HEPT-TUBE STRUCTURE; WITHOUT AMPLIMESH; 24-INCH LEGS
57-6839-24	PICKUP CAB RACKS; FORD SUPER DUTY 1999-2014; HEPT-TUBE STRUCTURE; WITH LOUVERS AND DIAMOND PLATE; 24-INCH LEGS
57-6850-24	PICKUP CAB RACKS; FORD FLARESIDE, 1997+; WITH AMPLIMESH AND DIAMOND PLATE; 24-INCH LEGS
57-6857-24	PICKUP CAB RACKS; FORD FLARESIDE, 1997+; WITHOUT MESH; 24-INCH LEGS
57-6859-24	PICKUP CAB RACKS; FORD FLARESIDE, 1997+; WITH LOUVERS AND DIAMOND PLATE; 24-INCH LEGS
57-6860-24	PICKUP CAB RACKS; FORD F150 STYLE SIDE 1997-2003; HEPT-TUBE STRUCTURE; WITH AMPLIMESH AND DIAMOND PLATE; 24-INCH LEGS
57-6867-24	PICKUP CAB RACKS; FORD F150 STYLE SIDE 1997-2003; HEPT-TUBE STRUCTURE; WITHOUT AMPLIMESH; 24-INCH LEGS
57-6869-24	PICKUP CAB RACKS; FORD F150 STYLE SIDE 1997-2003; HEPT-TUBE STRUCTURE; WITH LOUVERS AND DIAMOND PLATE; 24-INCH LEGS
57-6870-24	PICKUP CAB RACKS; FORD F150 2004-2014; HEPT-TUBE STRUCTURE; WITH AMPLIMESH AND DIAMOND PLATE; 24-INCH LEGS
57-6877-24	PICKUP CAB RACKS -FORD F150 2004-2014; HEPT-TUBE STRUCTURE; WITHOUT AMPLIMESH; 24-INCH LEGS
57-6879-24	PICKUP CAB RACKS; FORD F150 2004-2014; HEPT-TUBE STRUCTURE; WITH LOUVERS AND DIAMOND PLATE; 24-INCH LEGS
57-6920-24	PICKUP CAB RACKS; TOYOTA TACOMA 1995-2004; HEPT-TUBE STRUCTURE; WITH AMPLIMESH AND DIAMOND PLATE; 24-INCH LEGS
57-6927-24	PICKUP CAB RACKS; TOYOTA TACOMA 1995-2004; HEPT-TUBE STRUCTURE; WITHOUT AMPLIMESH; 24-INCH LEGS
57-6929-24	PICKUP CAB RACKS; TOYOTA TACOMA 1995-2004; HEPT-TUBE STRUCTURE; WITH LOUVERS AND DIAMOND PLATE; 24-INCH LEGS
57-6930-24	PICKUP CAB RACKS; TOYOTA TACOMA 2005-2014; HEPT-TUBE STRUCTURE; WITH AMPLIMESH AND DIAMOND PLATE; 24-INCH LEGS
57-6937-24	PICKUP CAB RACKS; TOYOTA TACOMA 2005-2014; HEPT-TUBE STRUCTURE; WITHOUT AMPLIMESH; 24-INCH LEGS
57-6939-24	PICKUP CAB RACKS; TOYOTA TACOMA 2005-2014; HEPT-TUBE STRUCTURE; WITH LOUVERS AND DIAMOND PLATE; 24-INCH LEGS
57-6940-24	PICKUP CAB RACKS; TOYOTA T100, TUNDRA 1993-2006; HEPT-TUBE STRUCTURE; WITH AMPLIMESH AND DIAMOND PLATE; 24-INCH LEGS
57-6947-24	PICKUP CAB RACKS; TOYOTA T100, TUNDRA 1993-2006; HEPT-TUBE STRUCTURE; WITHOUT AMPLIMESH; 24-INCH LEGS
57-6949-24	PICKUP CAB RACKS; TOYOTA T100, TUNDRA 1993-2006; HEPT-TUBE STRUCTURE; WITH LOUVERS AND DIAMOND PLATE; 24-INCH LEGS
57-6950-24	PICKUP CAB RACKS; TOYOTA TUNDRA 2007-2014; HEPT-TUBE STRUCTURE; WITH AMPLIMESH AND DIAMOND PLATE; 24-INCH LEGS
57-6957-24	PICKUP CAB RACKS; TOYOTA TUNDRA 2007-2014; HEPT-TUBE STRUCTURE; WITHOUT AMPLIMESH; 24-INCH LEGS

PICKUP TRUCK CAB RACKS — 24-INCH LEGS (Continued)	
57-6959-24	PICKUP CAB RACKS; TOYOTA TUNDRA 2007-2014; HEPT-TUBE STRUCTURE; WITH LOUVERS AND DIAMOND PLATE; 24-INCH LEGS
57-6960-24	PICKUP CAB RACKS; TOYOTA TUNDRA 2014; HEPT-TUBE STRUCTURE; WITH AMPLIMESH AND DIAMOND PLATE; 24-INCH LEGS
57-6967-24	PICKUP CAB RACKS; TOYOTA TUNDRA 2014; HEPT-TUBE STRUCTURE; WITHOUT AMPLIMESH; 24-INCH LEGS
57-6969-24	PICKUP CAB RACKS; TOYOTA TUNDRA 2014; HEPT-TUBE STRUCTURE; WITH LOUVERS AND DIAMOND PLATE; 24-INCH LEGS
57-6980-24	PICKUP CAB RACKS; EARLY TOYOTA ; HEPT-TUBE STRUCTURE; WITH AMPLIMESH AND DIAMOND PLATE; 24-INCH LEGS
57-6987-24	PICKUP CAB RACKS; EARLY TOYOTA ; HEPT-TUBE STRUCTURE; WITHOUT AMPLIMESH; 24-INCH LEGS
57-6989-24	PICKUP CAB RACKS; EARLY TOYOTA ; HEPT-TUBE STRUCTURE; WITH LOUVERS AND DIAMOND PLATE; 24-INCH LEGS
57-62150-24	PICKUP CAB RACKS; CHEVY COLORADO; HEPT-TUBE STRUCTURE; WITH AMPLIMESH AND DIAMOND PLATE; 24-INCH LEGS
57-62157-24	PICKUP CAB RACKS; CHEVY COLORADO; HEPT-TUBE STRUCTURE; WITHOUT AMPLIMESH; 24-INCH LEGS
57-62159-24	PICKUP CAB RACKS; CHEVY COLORADO; HEPT-TUBE STRUCTURE; WITH LOUVERS AND DIAMOND PLATE; 24-INCH LEGS
57-63150-24	PICKUP CAB RACKS; 2015 FULL SIZE DODGE RAM; HEPT-TUBE STRUCTURE; WITH AMPLIMESH AND DIAMOND PLATE; 24-INCH LEGS
57-63157-24	PICKUP CAB RACKS; 2015 FULL SIZE DODGE RAM; HEPT-TUBE STRUCTURE; WITHOUT AMPLIMESH; 24-INCH LEGS
57-63159-24	PICKUP CAB RACKS; 2015 FULL SIZE DODGE RAM; HEPT-TUBE STRUCTURE; WITH LOUVERS AND DIAMOND PLATE; 24-INCH LEGS
57-64150-24	PICKUP CAB RACKS; CHEVY SILVERADO 2015; HEPT-TUBE STRUCTURE; WITH AMPLIMESH AND DIAMOND PLATE; 24-INCH LEGS
57-64157-24	PICKUP CAB RACKS; CHEVY SILVERADO 2015; HEPT-TUBE STRUCTURE; WITHOUT AMPLIMESH; 24-INCH LEGS
57-64159-24	PICKUP CAB RACKS; CHEVY SILVERADO 2015; HEPT-TUBE STRUCTURE; WITH LOUVERS AND DIAMOND PLATE; 24-INCH LEGS

PICKUP TRUCK CAB RACKS — 32-INCH LEGS	
57-6440-32	PICKUP CAB RACKS; CHEVY SILVERADO 2007-2014; HEPT-TUBE STRUCTURE; WITH AMPLIMESH AND DIAMOND PLATE; 32" LEGS
57-6447-32	PICKUP CAB RACKS; CHEVY SILVERADO 2007-2014; HEPT-TUBE STRUCTURE; WITHOUT AMPLIMESH; 32" LEGS
57-6449-32	PICKUP CAB RACKS; CHEVY SILVERADO 2007-2014; HEPT-TUBE STRUCTURE; WITH LOUVERS AND DIAMOND PLATE; 32" LEGS
57-6430-32	PICKUP CAB RACKS; CHEVY SILVERADO 1999-2006; HEPT-TUBE STRUCTURE; WITH AMPLIMESH AND DIAMOND PLATE; 32" LEGS
57-6437-32	PICKUP CAB RACKS; CHEVY SILVERADO 1999-2006; HEPT-TUBE STRUCTURE; WITHOUT AMPLIMESH; 32" LEGS
57-6439-32	PICKUP CAB RACKS; CHEVY SILVERADO 1999-2006; HEPT-TUBE STRUCTURE; WITH LOUVERS AND DIAMOND PLATE; 32" LEGS
57-6240-32	PICKUP CAB RACKS; CHEVY FULL-SIZE 1988-1998; HEPT-TUBE STRUCTURE; WITH AMPLIMESH AND DIAMOND PLATE; 32" LEGS

PICKUP TRUCK

PICKUP TRUCK CAB RACKS — 32-INCH LEGS (Continued)	
57-6247-32	PICKUP CAB RACKS; CHEVY FULL-SIZE 1988-1998; HEPT-TUBE STRUCTURE; WITHOUT AMPLIMESH; 32" LEGS
57-6249-32	PICKUP CAB RACKS; CHEVY FULL-SIZE 1988-1998; HEPT-TUBE STRUCTURE; WITH LOUVERS AND DIAMOND PLATE; 32" LEGS
57-6230-32	PICKUP CAB RACKS; CHEVY COLORADO / GMC CANYON; HEPT-TUBE STRUCTURE; WITH AMPLIMESH AND DIAMOND PLATE; 32" LEGS
57-6237-32	PICKUP CAB RACKS; CHEVY COLORADO / GMC CANYON; HEPT-TUBE STRUCTURE; WITHOUT AMPLIMESH; 32" LEGS
57-6239-32	PICKUP CAB RACKS; CHEVY COLORADO / GMC CANYON; HEPT-TUBE STRUCTURE; WITH LOUVERS AND DIAMOND PLATE; 32" LEGS
57-6220-32	PICKUP CAB RACKS; CHEVY S-10; HEPT-TUBE STRUCTURE; WITH AMPLIMESH AND DIAMOND PLATE; 32" LEGS
57-6227-32	PICKUP CAB RACKS; CHEVY S-10; HEPT-TUBE STRUCTURE; WITHOUT AMPLIMESH; 32" LEGS
57-6229-32	PICKUP CAB RACKS; CHEVY S-10; HEPT-TUBE STRUCTURE; WITH LOUVERS AND DIAMOND PLATE; 32" LEGS
57-6370-32	PICKUP CAB RACKS; DODGE 2500 2010-2014, FORD F150 1973-1996, DODGE 1500 6 1/2' AND 8 1/2' BOX 2009-2014; HEPT-TUBE STRUCTURE; WITH AMPLIMESH AND DIAMOND PLATE; 32" LEGS
57-6377-32	PICKUP CAB RACKS; DODGE 2500 2010-2014, FORD F150 1973-1996, DODGE 1500 6 1/2' AND 8 1/2' BOX 2009-2014; HEPT-TUBE STRUCTURE; WITHOUT AMPLIMESH; 32" LEGS
57-6379-32	PICKUP CAB RACKS; DODGE 2500 2010-2014, FORD F150 1973-1996, DODGE 1500 6 1/2' AND 8 1/2' BOX 2009-2014; HEPT-TUBE STRUCTURE; WITH LOUVERS AND DIAMOND PLATE; 32" LEGS
57-6360-32	PICKUP CAB RACKS; DODGE 1500 5 1/2' BOX- 2009-2014; HEPT-TUBE STRUCTURE; WITH AMPLIMESH AND DIAMOND PLATE; 32" LEGS
57-6367-32	PICKUP CAB RACKS; DODGE 1500 5 1/2' BOX- 2009-2014; HEPT-TUBE STRUCTURE; WITHOUT AMPLIMESH; 32" LEGS
57-6369-32	PICKUP CAB RACKS; DODGE 1500 5 1/2' BOX- 2009-2014; HEPT-TUBE STRUCTURE; WITH LOUVERS AND DIAMOND PLATE; 32" LEGS
57-6350-32	PICKUP CAB RACKS; DODGE FULL-SIZE 2003-2009, DODGE 1500 2002-2008; HEPT-TUBE STRUCTURE; WITH AMPLIMESH AND DIAMOND PLATE; 32" LEGS
57-6357-32	PICKUP CAB RACKS; DODGE FULL-SIZE 2003-2009, DODGE 1500 2002-2008; HEPT-TUBE STRUCTURE; WITHOUT AMPLIMESH; 32" LEGS
57-6359-32	PICKUP CAB RACKS; DODGE FULL-SIZE 2003-2009, DODGE 1500 2002-2008; HEPT-TUBE STRUCTURE; WITH LOUVERS AND DIAMOND PLATE; 32" LEGS
57-6340-32	PICKUP CAB RACKS; DODGE FULL-SIZE 1973-2002, DODGE 1500 1973-2001; HEPT-TUBE STRUCTURE; WITH AMPLIMESH AND DIAMOND PLATE; 32" LEGS
57-6347-32	PICKUP CAB RACKS; DODGE FULL-SIZE 1973-2002, DODGE 1500 1973-2001; HEPT-TUBE STRUCTURE; WITHOUT AMPLIMESH; 32" LEGS
57-6349-32	PICKUP CAB RACKS; DODGE FULL-SIZE 1973-2002, DODGE 1500 1973-2001; HEPT-TUBE STRUCTURE; WITH LOUVERS AND DIAMOND PLATE; 32" LEGS
57-6320-32	PICKUP CAB RACKS; DODGE DAKOTA; HEPT-TUBE STRUCTURE; WITH AMPLIMESH AND DIAMOND PLATE; 32" LEGS
57-6327-32	PICKUP CAB RACKS; DODGE DAKOTA; HEPT-TUBE STRUCTURE; WITHOUT AMPLIMESH; 32" LEGS
57-6329-32	PICKUP CAB RACKS; DODGE DAKOTA; HEPT-TUBE STRUCTURE; WITH LOUVERS AND DIAMOND PLATE; 32" LEGS

PICKUP TRUCK CAB RACKS — 32-INCH LEGS (Continued)	
57-6830-32	PICKUP CAB RACKS; FORD SUPER DUTY 1999-2014; HEPT-TUBE STRUCTURE; WITH AMPLIMESH AND DIAMOND PLATE; 32" LEGS
57-6837-32	PICKUP CAB RACKS; FORD SUPER DUTY 1999-2014; HEPT-TUBE STRUCTURE; WITHOUT AMPLIMESH; 32" LEGS
57-6839-32	PICKUP CAB RACKS; FORD SUPER DUTY 1999-2014; HEPT-TUBE STRUCTURE; WITH LOUVERS AND DIAMOND PLATE; 32" LEGS
57-6530-32	PICKUP CAB RACKS; F250 / F350 1973-1997; HEPT-TUBE STRUCTURE; WITH AMPLIMESH AND DIAMOND PLATE; 32" LEGS
57-6537-32	PICKUP CAB RACKS; F250 / F350 1973-1997; HEPT-TUBE STRUCTURE; WITHOUT AMPLIMESH; 32" LEGS
57-6539-32	PICKUP CAB RACKS; F250 / F350 1973-1997; HEPT-TUBE STRUCTURE; WITH LOUVERS AND DIAMOND PLATE; 32" LEGS
57-6870-32	PICKUP CAB RACKS; FORD F150 2004-2014; HEPT-TUBE STRUCTURE; WITH AMPLIMESH AND DIAMOND PLATE; 32" LEGS
57-6877-32	PICKUP CAB RACKS; FORD F150 2004-2014; HEPT-TUBE STRUCTURE; WITHOUT AMPLIMESH; 32" LEGS
57-6879-32	PICKUP CAB RACKS; FORD F150 2004-2014; HEPT-TUBE STRUCTURE; WITH LOUVERS AND DIAMOND PLATE; 32" LEGS
57-6860-32	PICKUP CAB RACKS; FORD F150 STYLE SIDE 1997-2003; HEPT-TUBE STRUCTURE; WITH AMPLIMESH AND DIAMOND PLATE; 32" LEGS
57-6867-32	PICKUP CAB RACKS; FORD F150 STYLE SIDE 1997-2003; HEPT-TUBE STRUCTURE; WITHOUT AMPLIMESH; 32" LEGS
57-6869-32	PICKUP CAB RACKS; FORD F150 STYLE SIDE 1997-2003; HEPT-TUBE STRUCTURE; WITH LOUVERS AND DIAMOND PLATE; 32" LEGS
57-6520-32	PICKUP CAB RACKS; FORD RANGER; HEPT-TUBE STRUCTURE; WITH AMPLIMESH AND DIAMOND PLATE; 32" LEGS
57-6527-32	PICKUP CAB RACKS; FORD RANGER; HEPT-TUBE STRUCTURE; WITHOUT AMPLIMESH; 32" LEGS
57-6529-32	PICKUP CAB RACKS; FORD RANGER; HEPT-TUBE STRUCTURE; WITH LOUVERS AND DIAMOND PLATE; 32" LEGS
57-6720-32	PICKUP CAB RACKS; NISSAN FRONTIER 1998-2003; HEPT-TUBE STRUCTURE; WITH AMPLIMESH AND DIAMOND PLATE; 32" LEGS
57-6727-32	PICKUP CAB RACKS; NISSAN FRONTIER 1998-2003; HEPT-TUBE STRUCTURE; WITHOUT AMPLIMESH; 32" LEGS
57-6729-32	PICKUP CAB RACKS; NISSAN FRONTIER 1998-2003; HEPT-TUBE STRUCTURE; WITH LOUVERS AND DIAMOND PLATE; 32" LEGS
57-6740-32	PICKUP CAB RACK; NISSAN FRONTIER 2004-2014; HEPT-TUBE STRUCTURE; WITH AMPLIMESH AND DIAMOND PLATE; 32" LEGS
57-6747-32	PICKUP CAB RACK; NISSAN FRONTIER 2004-2014; HEPT-TUBE STRUCTURE; WITHOUT AMPLIMESH; 32" LEGS
57-6749-32	PICKUP CAB RACK; NISSAN FRONTIER 2004-2014; HEPT-TUBE STRUCTURE; WITH LOUVERS AND DIAMOND PLATE; 32" LEGS
57-6730-32	PICKUP CAB RACKS; NISSAN TITAN; HEPT-TUBE STRUCTURE; WITH AMPLIMESH AND DIAMOND PLATE; 32" LEGS
57-6737-32	PICKUP CAB RACKS; NISSAN TITAN; HEPT-TUBE STRUCTURE; WITHOUT AMPLIMESH; 32" LEGS
57-6739-32	PICKUP CAB RACKS; NISSAN TITAN; HEPT-TUBE STRUCTURE; WITH LOUVERS AND DIAMOND PLATE; 32" LEGS
57-6950-32	PICKUP CAB RACKS; TOYOTA TUNDRA 2007-2014; HEPT-TUBE STRUCTURE; WITH AMPLIMESH AND DIAMOND PLATE; 32" LEGS

PICKUP TRUCK CAB RACKS

PICKUP TRUCK CAB RACKS — 32-INCH LEGS (Continued)	
57-6957-32	PICKUP CAB RACKS; TOYOTA TUNDRA 2007-2014; HEPT-TUBE STRUCTURE; WITHOUT AMPLIMESH; 32" LEGS
57-6959-32	PICKUP CAB RACKS; TOYOTA TUNDRA 2007-2014; HEPT-TUBE STRUCTURE; WITH LOUVERS AND DIAMOND PLATE; 32" LEGS
57-6940-32	PICKUP CAB RACKS; TOYOTA T100 , TUNDRA 1993-2006; HEPT-TUBE STRUCTURE; WITH AMPLIMESH AND DIAMOND PLATE; 32" LEGS
57-6947-32	PICKUP CAB RACKS; TOYOTA T100, TUNDRA 1993-2006; HEPT-TUBE STRUCTURE; WITHOUT AMPLIMESH; 32" LEGS
57-6949-32	PICKUP CAB RACKS; TOYOTA T100, TUNDRA 1993-2006; HEPT-TUBE STRUCTURE; WITH LOUVERS AND DIAMOND PLATE; 32" LEGS
57-6930-32	PICKUP CAB RACKS; TOYOTA TACOMA 2005-2014; HEPT-TUBE STRUCTURE; WITH AMPLIMESH AND DIAMOND PLATE; 32" LEGS
57-6937-32	PICKUP CAB RACKS; TOYOTA TACOMA 2005-2014; HEPT-TUBE STRUCTURE; WITHOUT AMPLIMESH; 32" LEGS
57-6939-32	PICKUP CAB RACKS; TOYOTA TACOMA 2005-2014; HEPT-TUBE STRUCTURE; WITH LOUVERS AND DIAMOND PLATE; 32" LEGS
57-6920-32	PICKUP CAB RACKS; TOYOTA TACOMA 1995-2004; HEPT-TUBE STRUCTURE; WITH AMPLIMESH AND DIAMOND PLATE; 32" LEGS
57-6927-32	PICKUP CAB RACKS; TOYOTA TACOMA 1995-2004; HEPT-TUBE STRUCTURE; WITHOUT AMPLIMESH; 32" LEGS
57-6929-32	PICKUP CAB RACKS; TOYOTA TACOMA 1995-2004; HEPT-TUBE STRUCTURE; WITH LOUVERS AND DIAMOND PLATE; 32" LEGS
57-6960-32	PICKUP CAB RACKS; TOYOTA TUNDRA 2014; HEPT-TUBE STRUCTURE; WITH AMPLIMESH AND DIAMOND PLATE; 32" LEGS
57-6967-32	PICKUP CAB RACKS; TOYOTA TUNDRA 2014; HEPT-TUBE STRUCTURE; WITHOUT AMPLIMESH; 32" LEGS
57-6969-32	PICKUP CAB RACKS; TOYOTA TUNDRA 2014; HEPT-TUBE STRUCTURE; WITH LOUVERS AND DIAMOND PLATE; 32" LEGS
57-6850-32	PICKUP CAB RACKS; FORD FLARESIDE, 1997+; HEPT-TUBE STRUCTURE; WITH AMPLIMESH AND DIAMOND PLATE; 32" LEGS
57-6857-32	PICKUP CAB RACKS; FORD FLARESIDE, 1997+; HEPT-TUBE STRUCTURE; WITHOUT AMPLIMESH; 32" LEGS
57-6859-32	PICKUP CAB RACKS; FORD FLARESIDE, 1997+; HEPT-TUBE STRUCTURE; WITH LOUVERS AND DIAMOND PLATE; 32" LEGS
57-6980-32	PICKUP CAB RACKS; EARLY TOYOTA; HEPT-TUBE STRUCTURE; WITH AMPLIMESH AND DIAMOND PLATE; 32" LEGS
57-6987-32	PICKUP CAB RACKS; EARLY TOYOTA; HEPT-TUBE STRUCTURE; WITHOUT AMPLIMESH; 32" LEGS
57-6989-32	PICKUP CAB RACKS; EARLY TOYOTA; HEPT-TUBE STRUCTURE; WITH LOUVERS AND DIAMOND PLATE; 32" LEGS
57-6450-32	PICKUP CAB RACKS; CHEVY SILVERADO 2015+; HEPT-TUBE STRUCTURE; WITH AMPLIMESH AND DIAMOND PLATE; 32" LEGS
57-6457-32	PICKUP CAB RACKS; CHEVY SILVERADO 2015+; HEPT-TUBE STRUCTURE; WITHOUT AMPLIMESH; 32" LEGS
57-6459-32	PICKUP CAB RACKS; CHEVY SILVERADO 2015+; HEPT-TUBE STRUCTURE; WITH LOUVERS AND DIAMOND PLATE; 32" LEGS
57-62150-32	PICKUP CAB RACKS; CHEVY COLORADO; HEPT-TUBE STRUCTURE; WITH AMPLIMESH AND DIAMOND PLATE; 32" LEGS
57-62157-32	PICKUP CAB RACKS; CHEVY COLORADO; HEPT-TUBE STRUCTURE; WITHOUT AMPLIMESH; 32" LEGS
57-62159-32	PICKUP CAB RACKS; CHEVY COLORADO; HEPT-TUBE STRUCTURE; WITH LOUVERS AND DIAMOND PLATE; 32" LEGS

PICKUP TRUCK CAB RACKS — EXTRA LENGTH		
57-6830-LB	PICKUP CAB RACKS; FORD SUPER DUTY 1999; HEPT-TUBE STRUCTURE; WITH AMPLIMESH AND DIAMOND PLATE; 99.25" LEGS	
57-6837-LB	PICKUP CAB RACKS; FORD SUPER DUTY 1999; HEPT-TUBE STRUCTURE; WITHOUT AMPLIMESH; 99.25" LEGS	
57-6839-LB	PICKUP CAB RACKS; FORD SUPER DUTY 1999; HEPT-TUBE STRUCTURE; WITH LOUVERS AND DIAMOND PLATE; 99.25" LEGS	
57-6870-LB	PICKUP CAB RACKS; FORD F150 LONG BED 2004; HEPT-TUBE STRUCTURE; WITH AMPLIMESH AND DIAMOND PLATE; EXT FEET	
57-6877-LB	PICKUP CAB RACKS; FORD F150 LONG BED 2004; HEPT-TUBE STRUCTURE; WITHOUT AMPLIMESH; EXT FEET	
57-6879-LB	PICKUP CAB RACKS; FORD F150 LONG BED 2004; HEPT-TUBE STRUCTURE; WITH LOUVERS AND DIAMOND PLATE; EXT FEET	
57-6350-LB	PICKUP CAB RACKS; 2002+ DODGE 1500; HEPT-TUBE STRUCTURE; WITH AMPLIMESH AND DIAMOND PLATE; 99.5" LEGS	
57-6357-LB	PICKUP CAB RACKS; 2002+ DODGE 1500; HEPT-TUBE STRUCTURE; WITHOUT AMPLIMESH; 99.5" LEGS	
57-6359-LB	PICKUP CAB RACKS; 2002+ DODGE 1500; HEPT-TUBE STRUCTURE; WITH LOUVERS AND DIAMOND PLATE; 99.5" LEGS	
57-6370-LB	PICKUP CAB RACKS; 2009+ DODGE 1500 8' BED, WITH AMPLIMESH AND DIAMOND PLATE, 98-1/8" LEGS	
57-6377-LB	PICKUP CAB RACKS; 2009+ DODGE 1500 8' BED, WITHOUT AMPLIMESH, 98-1/8" LEGS	
57-6379-LB	PICKUP CAB RACKS; 2009+ DODGE 1500 8' BED, WITH LOUVERS AND DIAMOND PLATE, 98-1/8" LEGS	
57-6430-LB	PICKUP CAB RACKS; CHEVY SILVERADO 1999-2006; WITH AMPLIMESH AND DIAMOND PLATE; 97.5" LEGS	
57-6437-LB	PICKUP CAB RACKS; CHEVY SILVERADO 1999-2006; WITHOUT AMPLIMESH; 97.5" LEGS	
57-6439-LB	PICKUP CAB RACKS; CHEVY SILVERADO 1999-2006; WITH LOUVERS AND DIAMOND PLATE; 97.5" LEGS	
57-6440-LB	PICKUP CAB RACKS; CHEVY SILVERADO 2007+; WITH AMPLIMESH AND DIAMOND PLATE; 99.75" LEGS	
57-6447-LB	PICKUP CAB RACKS; CHEVY SILVERADO 2007+; WITHOUT AMPLIMESH; 99.75" LEGS	
57-6449-LB	PICKUP CAB RACKS; CHEVY SILVERADO 2007+; WITH LOUVERS AND DIAMOND PLATE; 99.75" LEGS	
SERVICE BODY CAB RACKS — 24-INCH LEGS		H
57-7518	SERVICE BODY CAB RACKS; ALUMINUM HEPT-TUBE STRUCTURE WITH AMPLIMESH; FIT: 54" CARGO BED WIDTHS	18
57-7519	SERVICE BODY CAB RACKS; ALUMINUM HEPT-TUBE STRUCTURE WITH AMPLIMESH; FIT: 54" CARGO BED WIDTHS	19
57-7520	SERVICE BODY CAB RACKS; ALUMINUM HEPT-TUBE STRUCTURE WITH AMPLIMESH; FIT: 54" CARGO BED WIDTHS	20
57-7521	SERVICE BODY CAB RACKS; ALUMINUM HEPT-TUBE STRUCTURE WITH AMPLIMESH; FIT: 54" CARGO BED WIDTHS	21
PICKUP BED REAR HOOP		
50-6245	REAR HOOP; ALUMINUM HEPT-TUBE STRUCTURE; CAPACITY 250-POUNDS; WELDED, 4" VERTICAL STOPS; FIT: CHEVY FULL SIZE 1988-1998	
50-6345	REAR HOOP; ALUMINUM HEPT-TUBE STRUCTURE; CAPACITY 250-POUNDS; WELDED, 4" VERTICAL STOPS; FIT: DODGE FULL-SIZE 1994-2003	

PICKUP TRUCK CAB RACKS / CAB RACK OPTIONS

PICKUP BED REAR HOOP (Continued)	
50-6355	REAR HOOP; ALUMINUM HEPT-TUBE STRUCTURE; CAPACITY 250-POUNDS; WELDED, 4" VERTICAL STOPS; FIT: DODGE FULL-SIZE, 2003-2009
50-6365	REAR HOOP; ALUMINUM HEPT-TUBE STRUCTURE; CAPACITY 250-POUNDS; WELDED, 4" VERTICAL STOPS; FIT: DODGE 1500-2009
50-6435	REAR HOOP; ALUMINUM HEPT-TUBE STRUCTURE; CAPACITY 250-POUNDS; WELDED, 4" VERTICAL STOPS; FIT: CHEVY SILVERADO 1999-2006
50-6445	REAR HOOP; ALUMINUM HEPT-TUBE STRUCTURE; CAPACITY 250-POUNDS; WELDED, 4" VERTICAL STOPS; FIT: CHEVY 2007-2009
50-6455	REAR HOOP; ALUMINUM HEPT-TUBE STRUCTURE; CAPACITY 250-POUNDS; WELDED, 4" VERTICAL STOPS; FIT: CHEVY SILVERADO 2015
50-6535	REAR HOOP; ALUMINUM HEPT-TUBE STRUCTURE; CAPACITY 250-POUNDS; WELDED, 4" VERTICAL STOPS; FIT: FORD FULL-SIZE 1992-1999
50-6735	REAR HOOP; ALUMINUM HEPT-TUBE STRUCTURE; CAPACITY 250-POUNDS; WELDED, 4" VERTICAL STOPS; FIT: NISSAN TITAN
50-6835	REAR HOOP; ALUMINUM HEPT-TUBE STRUCTURE; CAPACITY 250-POUNDS; WELDED, 4" VERTICAL STOPS; FIT: FORD SUPER DUTY 1999-2007
50-6845	REAR HOOP; ALUMINUM HEPT-TUBE STRUCTURE; CAPACITY 250-POUNDS; WELDED, 4" VERTICAL STOPS; FIT: FORD SUPER DUTY 2008-2009
50-6865	REAR HOOP; ALUMINUM HEPT-TUBE STRUCTURE; CAPACITY 250-POUNDS; WELDED, 4" VERTICAL STOPS; FIT: FORD F150 STYLESIDE 1997-2003
50-6875	REAR HOOP; ALUMINUM HEPT-TUBE STRUCTURE; CAPACITY 250-POUNDS; WELDED, 4" VERTICAL STOPS; FIT: FORD F150 2004-2009
50-6945	REAR HOOP; ALUMINUM HEPT-TUBE STRUCTURE; CAPACITY 250-POUNDS; WELDED, 4" VERTICAL STOPS; FIT: TOYOTA TUNDRA 1993-2006
50-6955	REAR HOOP; ALUMINUM HEPT-TUBE STRUCTURE; CAPACITY 250-POUNDS; WELDED, 4" VERTICAL STOPS; FIT: TOYOTA TUNDRA 2007-2009
50-6965	REAR HOOP; ALUMINUM HEPT-TUBE STRUCTURE; CAPACITY 250-POUNDS; WELDED, 4" VERTICAL STOPS; FIT: TOYOTA TUNDRA 2014-2015

PICKUP TRUCK CAB RACK CONFIGURED OPTIONS

PICKUP TRUCK CAB RACK LIGHT AND ANTENNA OPTIONS	
57-4445	LIGHT BRACKET WITH 1 ROUND LIGHT
57-4445-WL	LIGHT BRACKET WITH 1 ROUND WORK LIGHT
57-4446	LIGHT BRACKET WITH 2 ROUND LIGHTS
57-4447	LIGHT BRACKET WITH 1 OVAL LIGHT
57-4448	LIGHT BRACKET WITH 2 OVAL LIGHTS
57-6038	BEACON LIGHT PLATE, 7-INCH X 16-INCH RECTANGULAR
57-6040	BEACON LIGHT PLATE, 7-INCH ROUND
57-6042	BEACON LIGHT PLATE, 5.5-INCH ROUND
57-6044	BEACON LIGHT PLATE, 8-INCH ROUND
57-9000	LOAD LIGHT BRACKET
57-9005	ANTENNA BRACKET
57-9010	FRAMED CUTOUTS FOR LOAD LIGHTS

PICKUP TRUCK CAB RACK SIGN ASSEMBLIES

57-6034	OVERSIZE LOAD SIGN SOCKETS ONLY
57-6035	OVERSIZE LOAD SIGN BARS ONLY

CAB RACK OPTIONS



LIGHT BRACKETS

SHOWN: 57-4448 Bracket with 2 oval lights



OVERSIZE LOAD SIGN

SHOWN: 57-6037 60"W x 12"H wood sign, with socket and bar assembly, shown with flag holders (57-6065)



LUMBER STOPS

SHOWN: 57-6055 Pair of 4" vertical stops



LOAD LIGHT BRACKETS

SHOWN: 57-9000 Bracket is 2.5" x 2.5"



BEACON LIGHT MOUNTING PLATE

SHOWN: 57-6040 7" round mounting plates

PICKUP TRUCK CAB RACK SIGN ASSEMBLIES (Continued)

57-6036	SOCKET AND BAR ASSEMBLY ONLY, FOR 12-INCH X 60-INCH WOOD
57-6037	OVERSIZE LOAD SIGN, 12-INCH X 60-INCH WOOD SIGN, WITH SOCKET AND BAR ASSEMBLY

PICKUP TRUCK CAB RACK MOUNTED OPTIONS

57-6050	SLIDER WINDOW CUT OUT- LOUVERED
57-6052	SLIDER WINDOW CUT OUT-MESH
57-6055	4-INCH VERTICAL STOPS, PAIR
57-6065	FLAG HOLDER, (PAIR)
57-7015	ROPE HOOK, 0.5-INCH ALUMINUM
57-7017	ROPE LOOP, 0.5-INCH ALUMINUM
57-7019	ROPE CLEAT, 0.5-INCH ALUMINUM

PICKUP TRUCK CAB RACK POWDER COAT OPTIONS

57-6000-PCB	POWDER COAT BLACK
57-6000-PCW	POWDER COAT WHITE

PROTECH FARM & RANCH BODIES

PICKUP TRUCK STANDARD FLATBEDS. MORE THAN A FEED TRUCK.

FEATURES



RANCHER BODY 84"X102" (40-84102-RB) AND RANCHER BODY 96"X102" (40-96102-RB) Available in standard sizes for single or dual rear wheel pickup truck chassis

OPTIONS

- Underbody toolboxes (various)
- Mounting Kits for Ford, Chevy and Dodge
- 7-way RV socket in rear light panel (90-541327)

HEADBOARDS shaped for better visibility from side mirrors

One fuel-filler cup in the side rail.

ROUND, 1" 5052 ALUMINUM PIPE Offers handy, yet strong tie-off points

13" X 14" GOOSENECK TRAILER HITCH TRAPDOOR ACCESS

Centerline is 2" cab-side of axle



STAKE POCKETS

ALL LIGHTS ARE LEDs

TONGUE AND GROOVE INTERLOCKING BOARD DECK

Supports 1,000 lbs per lineal foot and delivers the equivalent deflection strength of steel, with significant weight savings and durability.

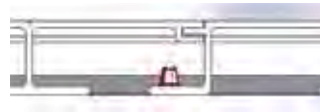

RIVETS ATTACH DECK BOARDS TO CROSSMEMBERS - NOT WELDS

This retains the parent metal strength and allows deck-flex.

RANCHER BODIES		W"	D"	H"
40-84102-RB	RANCHER BODY; 1.25-INCH INTERLOCKING TONGUE AND GROOVE EXTRUDED ALUMINUM I-BEAM DECK BOARDS; 5-INCH ZEE ALUMINUM ALLOY CROSS MEMBERS; 13-INCH X 14-INCH GOOSENECK TRAILER HITCH; TRAPDOOR ACCESS - CENTERLINE IS 2" CAB SIDE OF AXLE; LED LIGHTS - STOP, TURN, BACKUP, PLATE, SIDE; SINGLE FUEL FILLER CUP IN SIDE RAIL	84		102
40-96102-RB	RANCHER BODY 84-INCHx102-INCH; 1.25-INCH INTERLOCKING TONGUE AND GROOVE EXTRUDED ALUMINUM I-BEAM DECK BOARDS; 5-INCH ZEE ALUMINUM ALLOY CROSS MEMBERS; 13-INCH X 14-INCH GOOSENECK TRAILER HITCH; TRAPDOOR ACCESS - CENTERLINE IS 2" CAB SIDE OF AXLE; LED LIGHTS - STOP, TURN, BACKUP, PLATE, SIDE; SINGLE FUEL FILLER CUP IN SIDE RAIL	96		102
RANCHER BODY MOUNTING KITS		W"	D"	H"
40-10006-F	RANCHER BODY MOUNTING KIT — FORD			
40-10004-C	RANCHER BODY MOUNTING KIT — CHEVY			
40-10003-D	RANCHER BODY MOUNTING KIT — DODGE			
RANCHER BODY CONFIGURED OPTIONS		W"	D"	H"
41-13248	DEF-FILLER CUP (SINGLE)			
41-13245	FUEL-FILLER CUP (SINGLE)			
41-15001	MUD FLAP and HARDWARE KIT			
41-17500	HITCH GOOSENECK PLATE PARTS			

Note: See aluminum storage products section for rancher body toolboxes . Place options at time of order.

PROTECH BUILD TO SPEC™ PROGRAM

PROTECH BUILDS TO YOUR SPECIFICATIONS

When standard catalog products aren't what you need for your business, take advantage of the ProTech Build To Spec Program. From one-off special projects as diverse as brushfire trucks to beekeepers, ProTech is ready to execute the next idea. Take a look:



WILDLANDS FIRE TRUCK **Yakima Fire Department**

PROJECT GOAL:

Increase efficiency in fighting wildland fires.

Based on the ProTech flatbed, a transverse hose bay has through access from either side for hard suction hose and hot stick storage. A custom underride also housed the hose-fitting box with a T-handle. Special cabinetry was designed for hose hangers and other fire tools. Positive control T-locks permit one-handed rapid access for gloved hands. All cabinetry is in a custom color.



FLATWORK CONTRACTOR TRUCK **Parker Concrete**

PROJECT GOAL:

Standardize an up-fit package to meet field and operational needs for the fleet.

Built on the ProTech flatbed, the ProTech-designed material rack unbolts to allow access for truck engine maintenance. The rack also has special rack strap and securement placement based on worker access requirements. A special access bracket accommodates a longer underbody box install. Perforated locking toolboxes permit tool washing without tool removal.



HATCHERY FISH TRANSPORT TRUCK **East Fork State Fish Hatchery**

PROJECT GOAL:

Flatbed body capable of carrying large tank

The ProTech flatbed was designed with structural members 6 inches on center. To facilitate tank fish transfer, safety-grate catwalks are fabricated to raise 90° and supporting gussets are pulled from the bed rail storage position. When finished, side support gussets slide back into the side rail and the catwalk folds against the rail.



BUCKSTOP TRUCKWARE **DEMONSTRATION TRUCK**

Shown: ProTech storage boxes and flatbed designed with departure angle for offroad use.



POWER LINEMAN FOREMAN TRUCK
Bonneville Power Administration

PROJECT GOAL:

Reduce weight and increase field efficiency.

The foundation is the ProTech flatbed, on which were installed use-specific cabinets. The forward box is built through the flatbed body deck onto the frame rail. Heat registers for drying tools and clothes are built in. Drop and rise doors utilize full-length piano hinges and door pan stiffeners. Gas shocks assist full opening and easy closing in upper doors. Bottom drawer doubles as a workbench.



MULTI-SIDED LOAD ACCESS
J.R. Simplot

PROJECT GOAL:

Incorporate full access to truck bed for loading / unloading, with weight and fuel-savings.

The ProTech flatbed has extruded aluminum box channels welded to aluminum rail extrusions incorporated into the structure for thru-weld post rigidity. D-rings are riveted into the rail extrusions for load securement. Slats and stakes are ProTech proprietary 6061 aluminum extrusions. Slats are riveted to retain alignment and attachment. This combination allows extremely rigid, long swing-out panels as well as impact resistance during loading.

DURABILITY THAT DELIVERS ON ITS PROMISE.

ProTech makes off-the-shelf products, configured options and Build To Spec products. Three approaches that give truck owners the equipment that performs the way they expect it to on their truck. Durable. Functional. Long-lived. Why settle for a lesser standard.



www.protech.net

Vancouver, WA 1-800-443-6153 PO Box 933 Vancouver, WA 98666

La Vergne, TN 1-800-525-7998 PO Box 700 La Vergne, TN 37086

PROTECH
MADE IN USA

AS RUGGED AS THE JOB

